













SEPTEMBER 2024 EDITION

2024 CATALOGUE DOORS & GATES

TABLE OF CONTENTS:

	NOVELTIES	3
	EXTERIOR DOORS	11
	CONSTRUCTION	11
	GLAZED	29
	GLAZED WITH DECORS	57
	WITH DECORS	67
	FULL	71
	EXTERIOR DOUBLE-LEAF DOORS	83
	EXTERIOR DOORS WITH LIGHT	87
	SECURITY DOORS	91
	CONSTRUCTION	91
	WITH EMBOSSING	103
	WITH DECORS	115
	TECHNICAL DOORS	119
	CONSTRUCTION	119
	SECTIONAL GARAGE DOORS	125
	SECTIONAL INDUSTRIAL DOORS	133
	ALUMINIUM JOINERY	141
	TECHNICAL INFORMATION	145

In the individual sections of this catalogue we will present visualizations of selected models only, the full list of embossing patterns, glazing and decors can be found in the catalogue pages 150–154 and in the product configurator at royaldoors.co.uk

General Information

- Any information contained in the catalogue does not constitute an offer within the meaning of the Polish Civil Code and is published for information purposes only without any liability
- The drawings in the catalogue are for illustrative purposes only
- The presented colours and patterns may differ from the actual ones
- Colours from the RAL palette are available on special order
- Custom order will extend lead time and increase product price
- The manufacturer reserves the right to introduce changes to technical parameters and equipment of manufactured products without prior notice
- The declared parameters of the Ud coefficients refer to the reference dimensions
- All rights reserved © ROYAL DOORS

NOVELTIES



72ECOTHERM DOORS

The most important of the innovations prepared by Royal Doors for 2024 is the 72 Ecotherm door.

Excellent sealing, elimination of potential blowouts at the construction stage on connecting the leaf with the frame and sill, giving measurable savings resulting from the elimination of heat loss are just some of the advantages of the four-sided upstand, which the new steel doors are equipped with.

The 72 Ecotherm door is a 72 mm thick leaf with a four-sided upstand, filled with polyurethane foam, made of galvanised laminated or varnished sheet with a thickness of 0.6 mm, assembled on a steel and wooden frame, made of two blocks of pine plywood and two elements of galvanised laminated or varnished sheet, with a thickness of 0.6 mm and 1.2mm, respectively, allows for exceptional rigidity and excellent thermal insulation. The set is complemented with an aluminium sill with a thermal spacer, we recommend a three-layer installation, the so-called warm fitting with the use of a sub-sill foundation.



OPTIONALLY RC2CLASS DOOR

for doors with a thickness of 72 and 85 mm



With a view to single-family houses, we are expanding our offer by introducing the possibility of executing doors with a thickness of 72 mm and 85 mm in the RC2 class.

Increased resistance to burglary can be found in all door options, including doors glazed with security glass and doors with illumination.

NEW WRAPPERS

The already well-known Milan steel door wrapper, with a bent form that fits perfectly into our collection of glazing, embossing and decors, is expanded with other intriguing items: Ferrara and Arezzo.

Polish steel wrappers with excellent workmanship and interesting form complement the collection of modern steel door handles manufactured by Royal Doors

FERRARA



AREZZO



DOOR GLAZING WITH FRAME MADE OF BLACK GLASS



Black glass adds an elegant touch to the exterior door. Perfectly smooth surface and subtle play with light are the main advantages of frames made of this material. We are pleased that this sophisticated form of door glazing is already in our offer.

Black Lacobel is found under the numbers S80 and S81.

WARM-FRAME GLAZING PACKAGES



The current market situation means that door manufacturers put great emphasis on the development of their products towards ever better thermal parameters, no wonder – ecology and economy go hand in hand here. When deciding on the choice of exterior doors, consumers pay attention not only to the design, but also to the non-aesthetic values, which include the thermal conductivity parameter.

Thanks to the continuous development of our products, we have decided to replace the existing glazing packages in our 72 mm thick doors with glazing packages with warm frames. We believe that the changes we are introducing will meet with a friendly reception both on the part of our current and potential business partners.

NEW COLOURS

The front door is the background of many important events of our life – greetings and goodbyes. Make this background reflect your character. Steel entrance doors give you amazing possibilities in terms of colour selection, and at the same time they will not ruin your household budget.

New colours of laminates in the Royal Doors product range:

RED

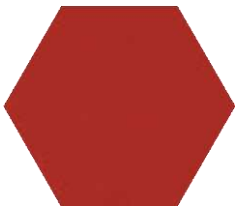

BLUE



GREEN



BLACK
STRUCTURAL



AV3 ELECTROMAGNETIC LOCK

with fingerprint reader

Various types of products are becoming an increasingly popular alternative to the traditional handle, exploiting technology to make life easier and simpler – instead of a key – a fingerprint.

One-time programming of fingerprints allows you to conveniently open the door with your fingerprint. The problem of losing the keys is eliminated. This innovative access control system also takes into account minor changes, such as finger enlargement in children as they grow.

Combining the reader with an automatic electric multi-point lock with is an extremely convenient way to open the door – just a touch of the scanner and the door will open on its own.

Doors with an electromagnetic lock are priced on individual request.



NAME	THICKNESS	FILLING	GLAZING	JAMB	SILL	SIZE	UD W/(M ² K)
OTHER EXECUTION OPTIONS	85 mm	POLYURETHANE FOAM	SOLID	ALUMINIUM WITH FILLING	ALUMINIUM	REF. SIZ.	0,80
	85 mm	POLYURETHANE FOAM	SOLID	ALUMINIUM	ALUMINIUM	REF. SIZ.	0,85
	85 mm	POLYURETHANE FOAM	GLAZED	ALUMINIUM	ALUMINIUM	REF. SIZ.	0,96
	85 mm	FOAMED POLYSTYRENE	SOLID	ALUMINIUM	ALUMINIUM	REF. SIZ.	0,93
	85 mm	FOAMED POLYSTYRENE	GLAZED	ALUMINIUM	ALUMINIUM	REF. SIZ.	1,0
	72 mm	POLYURETHANE FOAM	SOLID	ALUMINIUM	ALUMINIUM	REF. SIZ.	0,88
	72 mm	POLYURETHANE FOAM	GLAZED	ALUMINIUM	ALUMINIUM	REF. SIZ.	0,97
	72 mm	FOAMED POLYSTYRENE	SOLID	ALUMINIUM	ALUMINIUM	REF. SIZ.	0,98
	72 mm	POLYURETHANE FOAM	SOLID	STEEL- - WOODEN	STEEL	REF. SIZ.	1,0
	72 mm	POLYURETHANE FOAM	SOLID	ALUMINIUM	STEEL	REF. SIZ.	1,1
	72 mm	FOAMED POLYSTYRENE	SOLID	STEEL- - WOODEN	ALUMINIUM	REF. SIZ.	1,1
	72 mm	FOAMED POLYSTYRENE	SOLID	ALUMINIUM	STEEL	REF. SIZ.	1,2
	72 mm	POLYURETHANE FOAM	GLAZED	STEEL- - WOODEN	STEEL	REF. SIZ.	1,3
	72 mm	POLYURETHANE FOAM	GLAZED	ALUMINIOWA	STEEL	REF. SIZ.	1,3
	72 mm	FOAMED POLYSTYRENE	GLAZED PVC	STEEL- - WOODEN	ALUMINIUM	REF. SIZ.	1,3
	55 mm	POLYURETHANE FOAM	SOLID	ALUMINIUM	STEEL	REF. SIZ.	1,1
	55 mm	POLYURETHANE FOAM	SOLID	STEEL- - WOODEN	STEEL	REF. SIZ.	1,1
	55 mm	FOAMED POLYSTYRENE	SOLID	STEEL- - WOODEN	STEEL	REF. SIZ.	1,3

WARM ASSEMBLY

Royal Doors has been conducting training in mechanical assembly for two years, and since 2023 has also been involved in promoting the idea of "warm assembly". At the turn of January and February, the Company participated in the "Monterjada" event at the Budma Fair in Poznań, where during partner assemblies with Selena (Tytans Wins), Soudal and Nyxon, modern assembly techniques were presented using expansion tapes, membranes, foams and sub-sill foundations. A wide range of technical possibilities allows for the use of three-layer assembly both in the replacement of woodwork and in new construction projects.

Three-layer assembly, commonly known as "warm assembly", is primarily an energy-saving measure and a solution that ensures perfect sealing of places where heat loss and moisture deposition occur most often. It also ensures that high-end hole joinery is mounted in a professional manner.

Even the highest class doors lose their properties when they are incorrectly assembled.

AVAILABLE VENEER COLOURS

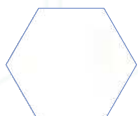

WHITE



WHITE WOOD-LIKE



LIGHT GREY



CONCRETE



BLEACHED OAK



SONOMA OAK



SHEFFIELD OAK



TURNER OAK



WINCHESTER



GOLDEN OAK

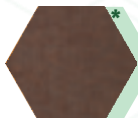

CORTEN



DARK WALNUT



RUSTIC OAK



HORIZONTAL



DARK MAHOGANY



SWAMP OAK



DARK ANTHRACITE



WOOD-LIKE ANTHRACITE



BLACK WOOD-LIKE

NEW COLOURS IN THE RANGE



RED



BLUE



GREEN



STRUCTURAL BLACK

* COLOURS AVAILABLE WHILE STOCK LAST

DETERMINING THE DIRECTION OF OPENING THE DOOR

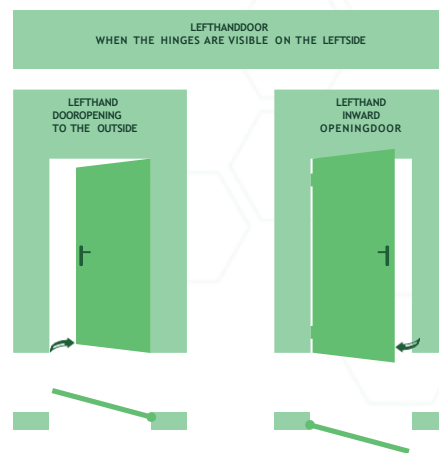
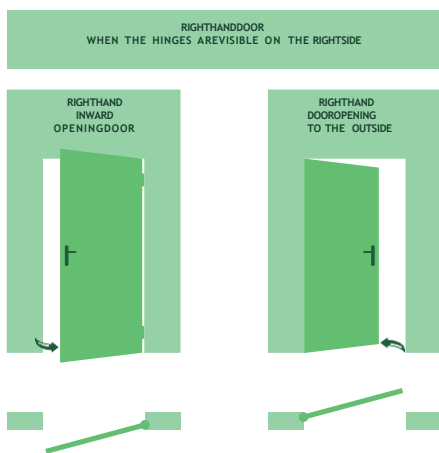

EXTERIOR DOORS



CONSTRUCTION

CONSTRUCTION OF DOORS

101MASTERHERM

 Ud from 0,70 W/(m²*K)

GLAZED DOOR

 Ud from 0,63 W/(m²*K)

FULL DOORS

 Rw = 30 dB

SOUND INSULATION INDEX FOR FULL DOORS

101MM THICK LEAF WITH FOUR-SIDED UP STAND, WITH DESIGN BASED ON A FULL WOODEN FRAME, MADE OF GALVANISED AND LAMINATED 0.6 MM STEEL SHEET FILLED WITH POLYURETHANE FOAM, EQUIPPED WITH TWO GASKETS



FOUR ANTI-BURGLARY PINS ON THE HINGED SIDE OF THE DOOR



THREE 3D HINGES WITH COVERS, ADJUSTABLE IN 3 PLANES



HOOK AND PIN MULTI-POINT SILENT LOCK



THREE HOOKS OF THE STRIP LOCK WITH ADJUSTABLE PRESSURE

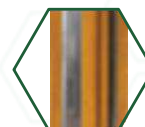

STEEL AND WOODEN FRAME CONSISTING OF 0.6MM GALVANISED SHEET AND PINE PLYWOOD, LAMINATED IN THE COLOUR OF THE LEAF, EQUIPPED WITH A GASKET



ALUMINIUM SILL WITH A THERMAL SEPARATOR INTEGRATED WITH THE FRAME



STP-H HANDLE



KNOB-INSERT



APPROVED CL. B INSERT



SAFETY CLASS RC 2

OPTION INCLUDES CERTIFIED INSERTS IN CL. B AND STP-H/K2 HANDLE

72ECOTHERM



Ud =0,88 W/(m²*K)

FULL DOORS



Ud =0,96 W/(m²*K)

GLAZED DOOR



Rw =30 dB

SOUND INSULATION INDEX FOR FULL DOORS



DOORSMADE TOSIZE



72MMTHICK LEAF WITH FOUR-SIDED UP STAND, MADE OF 0.6MM THICK GALVANISED LAMINATED SHEET, FILLED WITH POLYURETHANE FOAM, EQUIPPED WITH A GASKET



THREE ANTI-BURGLARYPINS ON THE HINGED SIDE OF THE DOOR



THREE 3D HINGES WITH COVERS, ADJUSTABLE IN 3 PLANES



THREE-BARTOP LOCK



THREE-BARMAIN LOCK



BAR LOCK WITH ADJUSTABLE PRESSURE



STEEL AND WOODEN FRAME CONSISTING OF GALVANIZEDSHEET WITH A THICKNESS OF 0.6 - 1.2MM AND PINE PLYWOOD, LAMINATED IN THE COLOUR OF THE LEAF, EQUIPPED WITH A GASKET



INTEGRATEDWITH THE FRAME THERMALLYSPACED ALUMINIUM SILL



STP-HHANDLE



INSERT AND KNOB-INSERT



CONSTRUCTION OF DOORS

85PREMIUM H ALU

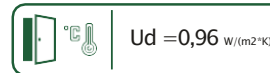

Ud = 0,96 W/(m²·K)

GLAZED DOOR

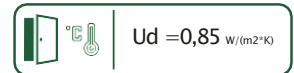

Ud = 0,85 W/(m²·K)

FULL DOORS



DOORS MADE
TO SIZE



Rw = 30 dB

SOUND INSULATION INDEX
FOR FULL DOORS



85MM-THICK LEAF WITH THREE-SIDED UPSTAND, MADE OF 0.6MM THICK GALVANIZED LAMINATED SHEET, FILLED WITH POLYURETHANE FOAM, FITTED WITH A GASKET



THREE ANTI-BURGLARY PINS ON THE HINGED SIDE OF THE DOOR



THREE Z5 HINGES



MACO MULTI-POINT LOCK WITH THREE LOCKING BOLTS AND SILENT LOCK



THREE HOOKS OF THE STRIP LOCK WITH ADJUSTABLE PRESSURE

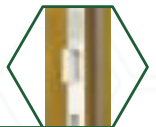

ALUMINIUM JAMB WITH THERMAL SPACER



ALUMINIUM SILL WITH A THERMAL SEPARATOR INTEGRATED WITH THE FRAME

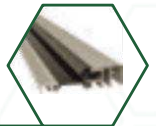

STP-H HANDLE



KNOB-INSERT



EXECUTION OPTIONS SUBJECT TO SURCHARGE



APPROVED CL. B
INSERT



SAFETY CLASS RC 2

OPTION INCLUDES CERTIFIED
INSERTS IN CL. B
AND STP-H/K2 HANDLE



ZAWIAS 3D



ALUMINIUM JAMB
WITH FILLING

85PREMIUM H PLUS



Ud = 0,91 W/(m²·K)

FULL DOORS

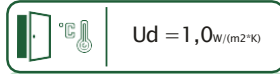

Ud = 1,0 W/(m²·K)

GLAZED DOOR



Rw = 30 dB

SOUND INSULATION INDEX FOR FULL DOORS



DOORS MADE TO SIZE



85MM THICK LEAF WITH THREE-SIDED UPSTAND, MADE OF 0.6MM THICK GALVANIZED LAMINATED SHEET, FILLED WITH POLYURETHANE FOAM / EQUIPPED WITH A GASKET

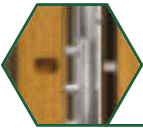

THREE ANTI-BURGLARY PINS ON THE HINGED SIDE OF THE DOOR



THREE REINFORCED DOUBLE-SPINDLE 3D HINGES, WITH COVERS, ADJUSTABLE IN 3 PLANES



MACO MULTI-POINT LOCK WITH THREE LOCKING BOLTS AND SILENT LOCK



THREE HOOKS OF THE STRIP LOCK WITH ADJUSTABLE PRESSURE



STEEL AND WOODEN FRAME CONSISTING OF GALVANIZED SHEET WITH A THICKNESS OF 0.6 - 1.2MM AND PINE PLYWOOD, LAMINATED IN THE COLOUR OF THE LEAF, EQUIPPED WITH A GASKET

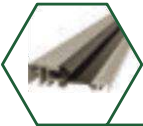

INTEGRATED WITH THE FRAME THERMALLY SPACED ALUMINIUM SILL



STP-H HANDLE



KNOB-INSERT



EXECUTION OPTIONS SUBJECT TO SURCHARGE



APPROVED CL. B INSERT



SAFETY CLASS RC2
OPTION INCLUDES CERTIFIED INSERTS IN CL. B AND STP-H/K2 HANDLE

CONSTRUCTION OF DOORS

85 PREMIUM ALU

 Ud = 0,96 W/(m²·K)

GLAZED DOOR

 Ud = 0,85 W/(m²·K)

FULL DOORS

 DOORS MADE TO SIZE

 Rw = 30 dB

SOUND INSULATION INDEX FOR FULL DOORS



85MM-THICK LEAF WITH THREE-SIDED UPSTAND, MADE OF 0.6MM THICK GALVANIZED LAMINATED SHEET, FILLED WITH POLYURETHANE FOAM, FITTED WITH A GASKET

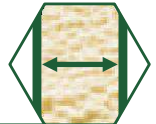

THREE ANTI-BURGLARY PINS ON THE HINGED SIDE OF THE DOOR



THREE Z5 HINGES



THREE-BAR TOP LOCK



THREE-BAR MAIN LOCK



BAR LOCK WITH ADJUSTABLE PRESSURE



ALUMINIUM JAMB WITH THERMAL SPACER



ALUMINIUM SILL WITH A THERMAL SEPARATOR INTEGRATED WITH THE FRAME

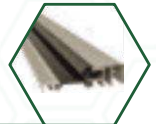

STP-H HANDLE



KNOB-INSERT



EXECUTION OPTIONS SUBJECT TO SURCHARGE



APPROVED CL. B INSERT



SAFETY CLASS RC2

OPTION INCLUDES CERTIFIED INSERTS IN CL. B AND STP-H/K2 HANDLE



3D HINGE



ALUMINIUM JAMB WITH FILLING

85PREMIUM PLUS

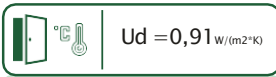

Ud = 0,91 W/(m²*K)

FULL DOORS

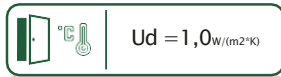

Ud = 1,0 W/(m²*K)

GLAZED DOOR



Rw = 30 dB

SOUND INSULATION INDEX FOR FULL DOORS



DOORS MADE TOSIZE



85MM THICK LEAF WITH THREE-SIDED UP STAND, MADE OF 0.6MM THICK GALVANISED LAMINATED SHEET, FILLED WITH POLYURETHANE FOAM, EQUIPPED WITH A GASKET



THREE ANTI-BURGLARY PINS ON THE HINGED SIDE OF THE DOOR



THREE ANTI-BURGLARY PINS ON THE HINGED SIDE OF THE DOOR



THREE-BAR TOP LOCK



THREE-BAR MAIN LOCK

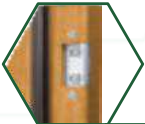

BAR LOCK WITH ADJUSTABLE PRESSURE



STEEL AND WOODEN FRAME CONSISTING OF GALVANIZED SHEET WITH A THICKNESS OF 0.6 - 1.2MM AND PINE PLYWOOD, LAMINATED IN THE COLOUR OF THE LEAF, EQUIPPED WITH A GASKET

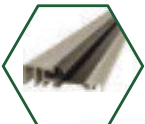

INTEGRATED WITH THE FRAME THERMALLY SPACED ALUMINIUM SILL



STP-H HANDLE



INSERT AND KNOB-INSERT



EXECUTION OPTIONS SUBJECT TO SURCHARGE



APPROVED CL. B INSERT



SAFETY CLASS RC2
OPTION INCLUDES CERTIFIED INSERTS IN CL. B AND STP-H/K2 HANDLE

CONSTRUCTION OF DOORS

85PREMIUM

Ud = 1,3 W/(m²*K)

GLAZED DOOR

Ud = 1,1 W/(m²*K)

FULL DOORS

DOORS MADE TO SIZE

Rw = 30 dB

SOUND INSULATION INDEX FOR FULL DOORS

85MM-THICK LEAF WITH THREE-SIDED UP STAND, MADE OF 0.6MM THICK GALVANISED LAMINATED SHEET, FILLED WITH POLYURETHANE FOAM, FITTED WITH A GASKET



THREE ANTI-BURGLARY PINS ON THE HINGED SIDE OF THE DOOR



THREE THREE-SECTION Z5 HINGES



THREE-BAR TOP LOCK



THREE-BAR MAIN LOCK



BAR LOCK WITH ADJUSTABLE PRESSURE



STEEL FRAME MADE OF GALVANISED SHEET WITH A THICKNESS OF 1.2MM, LAMINATED IN THE COLOUR OF THE LEAF, EQUIPPED WITH A GASKET



STEEL SILL WITH GASKET INTEGRATED WITH THE FRAME



STP-H HANDLE



INSERT AND KNOB-INSERT



AVAILABLE FRAME MODELS

W STANDARDISE



FD-25/21/B

ZA DOPLATA



ALUMINIUM WITH THERMAL SPACER



STEEL-WOODEN WITH 3DHINGE



ALUMINIUM WITH FILLING

EXECUTION OPTIONS SUBJECT TO SURCHARGE



APPROVED CL. B INSERT

SAFETY CLASS RC2

OPTION INCLUDES CERTIFIED AND STP-H/K2 HANDLE INSERTS IN CL. B



85 STANDARD

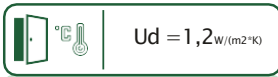

Ud = 1,2 W/(m²*K)

FULL DOORS

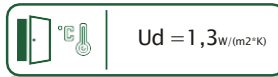

Ud = 1,3 W/(m²*K)

GLAZED DOOR



Rw = 30 dB

SOUND INSULATION INDEX FOR FULL DOORS



DOORS MADE TO SIZE



85MM THICK LEAF WITH THREE-SIDED UP STAND, MADE OF 0.6MM THICK GALVANISED LAMINATED SHEET, FILLED WITH EXPANDED POLYSTYRENE (POLYSTYRENE FOAM), EQUIPPED WITH A GASKET



THREE ANTI-BURGLARY PINS ON THE HINGED SIDE OF THE DOOR



THREE THREE-SECTION Z5 HINGES



THREE-BAR TOP LOCK



THREE-BAR MAIN LOCK



BAR LOCK WITH ADJUSTABLE PRESSURE



STEEL FRAME MADE OF GALVANISED SHEET WITH A THICKNESS OF 1.2MM, LAMINATED IN THE COLOUR OF THE LEAF, EQUIPPED WITH A GASKET



STEEL SILL WITH GASKET INTEGRATED WITH THE FRAME



STP-H HANDLE



INSERT AND KNOB-INSERT



EXECUTION OPTIONS SUBJECT TO SURCHARGE



APPROVED CL. B INSERT

SAFETY CLASS RC2

OPTION INCLUDES CERTIFIED AND STP-H/K2 HANDLE INSERTS IN CL. B



STANDARD



FD-25/21/B

FOR A SURCHARGE



ALUMINIUM WITH THERMAL SPACER



STEEL-WOODEN WITH 3D HINGE



ALUMINIUM WITH FILLING

AVAILABLE FRAME MODELS

CONSTRUCTION OF DOORS

72PREMIUM H ALU



Ud = 0,97 W/(m²*K)

GLAZED DOOR



Ud = 0,88 W/(m²*K)

FULL DOORS



DOORS MADE TO SIZE



Rw = 30 dB

SOUND INSULATION INDEX FOR FULL DOORS

72MM-THICK LEAF WITH THREE-SIDED UP STAND, MADE OF 0.6MM THICK GALVANISED LAMINATED SHEET, FILLED WITH POLYURETHANE FOAM, FITTED WITH A GASKET



THREE ANTI-BURGLARY PINS ON THE HINGED SIDE OF THE DOOR



THREE Z5 HINGES



WINKHAUS MULTI-POINT LATCH AND HOOK LOCK



LATCH LOCK BAR WITH ADJUSTABLE PRESSURE

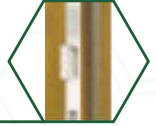

ALUMINIUM JAMB WITH THERMAL SPACER

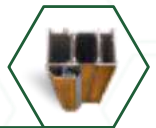

ALUMINIUM SILL WITH A THERMAL SEPARATOR INTEGRATED WITH THE FRAME

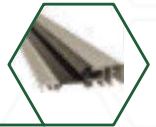

STP-H HANDLE



KNOB-INSERT



EXECUTION OPTIONS SUBJECT TO SURCHARGE



APPROVED CL. B INSERT



SAFETY CLASS RC 2
OPTION INCLUDES CERTIFIED INSERTS IN CL. B AND STP-H/K2 HANDLE



3D HINGE

72PREMIUM H PLUS

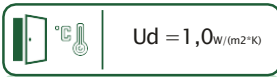

$U_d = 1,0_{W/(m^2 \cdot K)}$

FULL DOORS

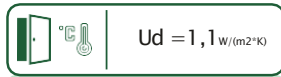

$U_d = 1,1_{W/(m^2 \cdot K)}$

GLAZED DOOR



$R_w = 30 \text{ dB}$

SOUND INSULATION INDEX FOR FULL DOORS



DOORS MADE TO SIZE



72MM THICK LEAF WITH THREE-SIDED UP STAND, MADE OF 0.6MM THICK GALVANISED LAMINATED SHEET, FILLED WITH POLYURETHANE FOAM, EQUIPPED WITH A GASKET

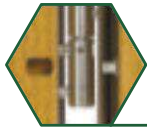

THREE ANTI-BURGLARY PINS ON THE HINGED SIDE OF THE DOOR



THREE 3D HINGES WITH COVERS, ADJUSTABLE IN 3 PLANES



WINKHAUS MULTI-POINT LATCH AND HOOK LOCK



LATCH LOCK BAR WITH ADJUSTABLE PRESSURE



STEEL AND WOODEN FRAME CONSISTING OF GALVANISED SHEET WITH A THICKNESS OF 0.6 - 1.2MM AND PINE PLYWOOD, LAMINATED IN THE COLOUR OF THE LEAF, EQUIPPED WITH A GASKET

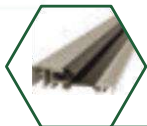

INTEGRATED WITH THE FRAME THERMALLY SPACED ALUMINIUM SILL



STP-H HANDLE



KNOB-INSERT



EXECUTION OPTIONS SUBJECT TO SURCHARGE



APPROVED CL. B INSERT



SAFETY CLASS RC2

OPTION INCLUDES CERTIFIED INSERTS IN CL. B AND STP-H/K2 HANDLE

CONSTRUCTION OF DOORS

72PREMIUM ALU



Ud = 0,97 W/(m²*K)

GLAZED DOOR



Ud = 0,88 W/(m²*K)

FULL DOORS



DOORS MADE TO SIZE



Rw = 30 dB

SOUND INSULATION INDEX FOR FULL DOORS

72MM-THICK LEAF WITH THREE-SIDED UP STAND, MADE OF 0.6MM THICK GALVANISED LAMINATED SHEET, FILLED WITH POLYURETHANE FOAM, FITTED WITH A GASKET



THREE ANTI-BURGLARY PINS ON THE HINGED SIDE OF THE DOOR



THREE Z5 HINGES



THREE-BAR TOP LOCK



THREE-BAR MAIN LOCK



BAR LOCK WITH ADJUSTABLE PRESSURE

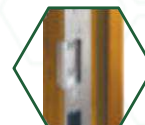

ALUMINIUM JAMB WITH THERMAL SPACER



ALUMINIUM SILL WITH A THERMAL SEPARATOR INTEGRATED WITH THE FRAME

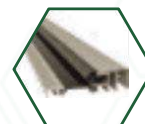

STP-H HANDLE



INSERT AND KNOB-INSERT IN ONE KEY SYSTEM



EXECUTION OPTIONS SUBJECT TO SURCHARGE



APPROVED CL. B INSERT



SAFETY CLASS RC 2

OPTION INCLUDES CERTIFIED INSERTS IN CL. B AND STP-H/K2 HANDLE



3D HINGE

72PREMIUM PLUS

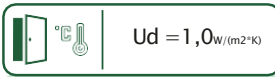

Ud = 1,0 W/(m²*K)

FULL DOORS

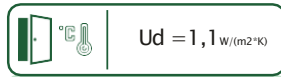

Ud = 1,1 W/(m²*K)

GLAZED DOOR



Rw = 30 dB

SOUND INSULATION INDEX FOR FULL DOORS



DOORS MADE TO SIZE



72MM THICK LEAF WITH THREE-SIDED UP STAND, MADE OF 0.6MM THICK GALVANISED LAMINATED SHEET, FILLED WITH POLYURETHANE FOAM, EQUIPPED WITH A GASKET

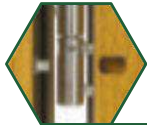

THREE ANTI-BURGLARY PINS ON THE HINGED SIDE OF THE DOOR

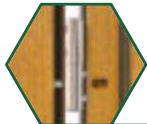

THREE 3D HINGES WITH COVERS, ADJUSTABLE IN 3 PLANES



THREE-BAR TOP LOCK



THREE-BAR MAIN LOCK



BAR LOCK WITH ADJUSTABLE PRESSURE



STEEL AND WOODEN FRAME CONSISTING OF GALVANISED SHEET WITH A THICKNESS OF 0.6 - 1.2MM AND PINE PLYWOOD, LAMINATED IN THE COLOUR OF THE LEAF, EQUIPPED WITH A GASKET

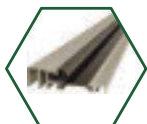

INTEGRATED WITH THE FRAME THERMALLY SPACED ALUMINIUM SILL



STP-H HANDLE



INSERT AND KNOB-INSERT IN ONE KEY SYSTEM



EXECUTION OPTIONS SUBJECT TO SURCHARGE



APPROVED CL. B INSERT



SAFETY CLASS RC2

OPTION INCLUDES CERTIFIED INSERTS IN CL. B AND STP-H/K2 HANDLE

CONSTRUCTION OF DOORS

72PREMIUM



Ud = 1,3_{W/(m²*K)}

GLAZED DOOR



Ud = 1,2_{W/(m²*K)}

FULL DOORS



DOORS MADE TO SIZE



Rw = 30 dB

SOUND INSULATION INDEX FOR FULL DOORS

72MM-THICK LEAF WITH THREE-SIDED UP STAND, MADE OF 0.6MM THICK GALVANISED LAMINATED SHEET, FILLED WITH POLYURETHANE FOAM, FITTED WITH A GASKET



THREE ANTI-BURGLARY PINS ON THE HINGED SIDE OF THE DOOR



THREE THREE-SECTION Z5 HINGES



THREE-BAR TOP LOCK



THREE-BAR MAIN LOCK



BAR LOCK WITH ADJUSTABLE PRESSURE



STEEL FRAME MADE OF GALVANISED SHEET WITH A THICKNESS OF 1.2MM, LAMINATED IN THE COLOUR OF THE LEAF, EQUIPPED WITH A GASKET



STEEL SILL WITH GASKET INTEGRATED WITH THE FRAME



STP-H HANDLE



INSERT AND KNOB-INSERT IN ONE KEY SYSTEM



AVAILABLE FRAME MODELS

STANDARD



FD-25/12



FD-25/21/B

FOR A SURCHARGE



ALUMINIUM WITH THERMAL SPACER



STEEL-WOODEN WITH 3D HINGE



FD-25/12 + GRILLE

EXECUTION OPTIONS SUBJECT TO SURCHARGE



APPROVED CL. B INSERT

SAFETY CLASS RC2

OPTION INCLUDES CERTIFIED INSERTS IN CL. B AND STP-H/K2 HANDLE



RC 2

72STANDARD

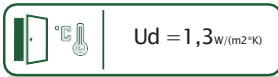

Ud = 1,3W/(m²*K)

FULL DOORS

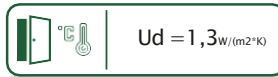

Ud = 1,3W/(m²*K)

GLAZED DOOR



Rw = 30 dB

SOUND INSULATION INDEX FOR FULL DOORS



DOORS MADE TO SIZE



72MMTHICK LEAF WITH THREE-SIDED UP STAND, MADE OF 0.6MM THICK GALVANISED LAMINATED SHEET, FILLED WITH EXPANDED POLYSTYRENE (POLYSTYRENE FOAM), EQUIPPED WITH A GASKET



THREE ANTI-BURGLARY PINS ON THE HINGED SIDE OF THE DOOR

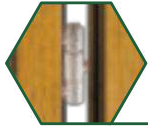

THREE THREE-SECTION Z5 HINGES



THREE-BAR TOP LOCK



THREE-BAR MAIN LOCK



BAR LOCK WITH ADJUSTABLE PRESSURE



STEEL FRAME MADE OF GALVANISED SHEET WITH A THICKNESS OF 1.2MM, LAMINATED IN THE COLOUR OF THE LEAF, EQUIPPED WITH A GASKET



STEEL SILL WITH GASKET INTEGRATED WITH THE FRAME



STP-H HANDLE



INSERT AND KNOB-INSERT IN ONE KEY SYSTEM



EXECUTION OPTIONS SUBJECT TO SURCHARGE



APPROVED CL. B INSERT

SAFETY CLASS RC2

OPTION INCLUDES CERTIFIED INSERTS IN CL. B AND STP-H/K2 HANDLE



STANDARD



FD-25/12



FD-25/21/B

FOR A SURCHARGE



ALUMINIUM WITH THERMAL SPACER



STEEL-WOODEN WITH 3D HINGE



FD-25/12 + GRILLE

AVAILABLE FRAME MODELS

CONSTRUCTION OF DOORS

55PREMIUM PLUS

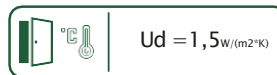

GLAZED DOOR



FULL DOORS



SOUND INSULATION INDEX FOR FULL DOORS

55MM-THICK LEAF WITH THREE-SIDED UP STAND, MADE OF 0.6MM THICK GALVANISED LAMINATED SHEET, FILLED WITH POLYURETHANE FOAM, FITTED WITH A GASKET



THREE ANTI-BURGLARY PINS ON THE HINGED SIDE OF THE DOOR



THREE 3D HINGES WITH COVERS, ADJUSTABLE IN 3 PLANES



THREE-BAR TOP LOCK



THREE-BAR MAIN LOCK



BAR LOCK WITH ADJUSTABLE PRESSURE



STEEL AND WOODEN FRAME CONSISTING OF 0.6-1.2MM GALVANISED SHEET AND PINE PLYWOOD, LAMINATED IN THE COLOUR OF THE LEAF, EQUIPPED WITH A GASKET



ALUMINIUM SILL WITH A THERMAL SPACER INTEGRATED WITH THE FRAME

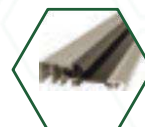

STP-H HANDLE



INSERT AND KNOB-INSERT IN ONE KEY SYSTEM



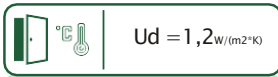

Ud = 1,2_{W/(m²*K)}

FULL DOORS

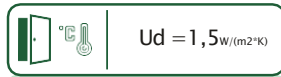

Ud = 1,5_{W/(m²*K)}

GLAZED DOOR



Rw = 27dB

SOUND INSULATION INDEX FOR FULL DOORS



DOORS MADE TO SIZE

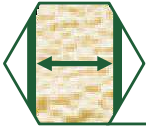

55MM THICK LEAF WITH THREE-SIDED UP STAND, MADE OF 0.6MM THICK GALVANISED LAMINATED SHEET, FILLED WITH POLYURETHANE FOAM, EQUIPPED WITH A GASKET



THREE ANTI-BURGLARY PINS ON THE HINGED SIDE OF THE DOOR



THREE THREE-SECTION Z5 HINGES



THREE-BAR TOP LOCK



THREE-BAR MAIN LOCK



BAR LOCK WITH ADJUSTABLE PRESSURE



STEEL FRAME MADE OF GALVANISED SHEET WITH A THICKNESS OF 1.2MM, LAMINATED IN THE COLOUR OF THE LEAF, EQUIPPED WITH GASKET



STEEL SILL WITH GASKET INTEGRATED WITH THE FRAME



STP-H HANDLE



INSERT AND KNOB-INSERT IN ONE KEY SYSTEM



AVAILABLE FRAME MODELS

STANDARD



FD-25/12



FD-25/21/B



FD-25/21/C

FOR A SURCHARGE



STEEL-WOODEN WITH 3D HINGE



FD-25/12 + GRILLE

CONSTRUCTION OF DOORS

55STANDARD



Ud = 1,6W/(m²K)

GLAZED DOOR



Ud = 1,3W/(m²K)

FULL DOORS



DOORS MADE TO SIZE



Rw = 27dB

SOUND INSULATION INDEX FOR FULL DOORS

55MM THICK LEAF WITH A THREE-SIDED UP STAND, MADE OF 0.6MM GALVANISED AND LAMINATED SHEET, FILLED WITH FOAMED POLYSTYRENE (STYROFOAM), EQUIPPED WITH A GASKET



THREE ANTI-BURGLARY PINS ON THE HINGED SIDE OF THE DOOR



THREE THREE-SECTION Z5 HINGES



THREE-BAR TOP LOCK



BAR LOCK WITH ADJUSTABLE PRESSURE



STEEL FRAME MADE OF GALVANISED SHEET WITH A THICKNESS OF 1.2MM, LAMINATED IN THE COLOUR OF THE LEAF, EQUIPPED WITH A GASKET



STEEL SILL WITH GASKET INTEGRATED WITH THE FRAME



STP-H HANDLE



INSERT AND KNOB-INSERT IN ONE KEY SYSTEM



AVAILABLE FRAME MODELS

STANDARD



FD-25/12



FD-25/21/B



FD-25/21/C

FOR A SURCHARGE



STEEL-WOODEN WITH 3D HINGE



FD-25/12 + GRILLE



EXTERIOR DOORS

GLAZED

STANDARD COLOURS

- WHITE
- WHITE WOOD-LIKE
- LIGHT GREY
- CONCRETE
- BLEACHED OAK
- SONOMA OAK
- SHEFFIELD OAK
- WINCHESTER
- GOLDEN OAK
- CORTEN
- DARK WALNUT
- RUSTIC OAK
- HORIZONTAL
- DARK MAHOGANY
- SWAMP OAK
- DARK ANTHRACITE
- WOOD-LIKE ANTHRACITE
- NEW !**
- RED
- BLUE
- GREEN
- STRUCTURAL BLACK

EXCLUSIVE COLOURS

- TURNER OAK
- BLACKWOOD-LIKE

DOORS IN SIZES 100N AND 100E AVAILABLE ONLY IN THE INDICATED COLOURS

COLOURS AVAILABLE WHILE STOCKS LAST

GLAZED EXTERIOR DOORS

NEW !

EMBOSSING T55

GLAZING S80

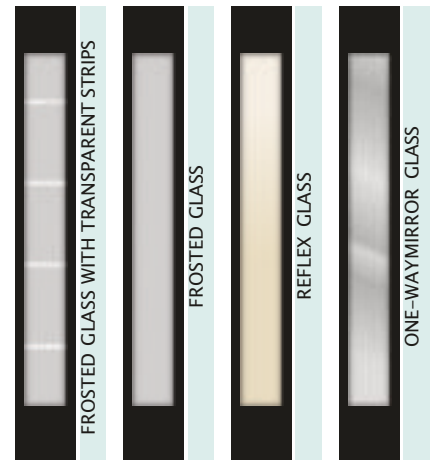

BLACK GLASS FRAME LACOBEL

	Ud
55 STANDARD	1,6
55 PREMIUM	1,5
55 PREMIUM PLUS	1,5
72 STANDARD	1,3
72 PREMIUM	1,3
72 PREMIUM PLUS	1,1
72 PREMIUM ALU	0,97
72 PREMIUM H PLUS	1,1
72 PREMIUM H ALU	0,97
85 STANDARD	1,3
85 PREMIUM	1,3
85 PREMIUM PLUS	1,0
85 PREMIUM ALU	0,96
85 PREMIUM H PLUS	1,0
85 PREMIUM H ALU	0,96
72 ECOTHERM	0,96
101 MASTER THERM	X

AVAILABLE SIZES:
80N, 80E, 90N, 90E, 100N, 100E

SURCHARGE FOR WIDTH 100

85MM THICK DOORS ARE MADE
IN COLOURS: WHITE, TURNER OAK, WINCHESTER,
GOLDEN OAK, DARK WALNUT, SWAMP OAK, DARK ANTHRACITE,
WOOD-LIKE ANTHRACITE, RED, BLUE, GREEN, STRUCTURAL BLACK
IN SIZES 80N, 80E, 90N, 90E

NEW !

GLAZED EXTERIOR DOORS

STANDARD COLOURS



G
S80



G
S80



T60
S80





T55
S80

-  WHITE
-  WHITE WOOD-LIKE
-  LIGHTGREY
-  CONCRETE
-  BLEACHED OAK
-  SONOMAOAK
-  SHEFFIELD OAK
-  WINCHESTER
-  GOLDEN OAK
-  CORTEN
-  DARKWALNUT
-  RUSTICAL OAK
-  HORIZONTAL
-  DARKMAHOGANY
-  SWAMP OAK
-  DARKANTHRACITE
-  WOOD-LIKE ANTHRACITE
- NEW !**
-  RED
-  BLUE
-  GREEN
-  STRUCTURAL BLACK

EXCLUSIVE COLOURS

-  TURNER OAK
-  BLACKWOOD-LIKE

 DOORS IN SIZES 100N AND 100E AVAILABLE ONLY IN THE INDICATED COLOURS

 COLOURS AVAILABLE WHILE STOCKS LAST

STANDARD COLOURS

- WHITE 
- WHITE WOOD-LIKE 
- LIGHT GREY 
- CONCRETE 
- BLEACHED OAK 
- SONOMA OAK 
- SHEFFIELD OAK 
- WINCHESTER 
- GOLDEN OAK 
- CORTEN 
- DARK WALNUT 
- RUSTIC OAK 
- HORIZONTAL 
- DARK MAHOGANY 
- SWAMP OAK 
- DARK ANTHRACITE 
- WOOD-LIKE ANTHRACITE 
- NEW !**
- RED 
- BLUE 
- GREEN 
- STRUCTURAL BLACK 

EXCLUSIVE COLOURS

- TURNER OAK 
- BLACKWOOD-LIKE 

DOORS IN SIZES 100N AND 100E AVAILABLE ONLY IN THE INDICATED COLOURS

COLOURS AVAILABLE WHILE STOCKS LAST

GLAZED EXTERIOR DOORS

NEW !

EMBOSSING T60

GLAZING S81

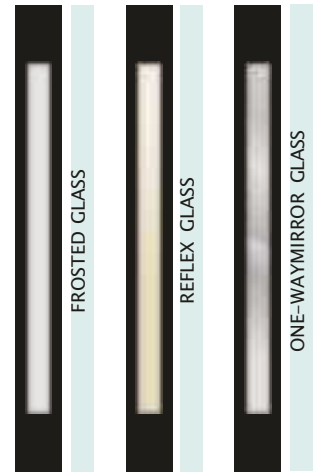

BLACK GLASS FRAME LACOBEL

	Ud
55 STANDARD	1,6
55 PREMIUM	1,5
55 PREMIUM PLUS	1,5
72 STANDARD	1,3
72 PREMIUM	1,3
72 PREMIUM PLUS	1,1
72 PREMIUM ALU	0,97
72 PREMIUM H PLUS	1,1
72 PREMIUM H ALU	0,97
85 STANDARD	1,3
85 PREMIUM	1,3
85 PREMIUM PLUS	1,0
85 PREMIUM ALU	0,96
85 PREMIUM H PLUS	1,0
85 PREMIUM H ALU	0,96
72 ECO THERM	0,96
101 MASTER THERM	X

AVAILABLE SIZES:
80N, 80E, 90N, 90E, 100N, 100E

SURCHARGE FOR WIDTH 100

85MM THICK DOORS ARE MADE
IN COLOURS: WHITE, TURNER OAK, WINCHESTER, GOLDEN OAK, DARK WALNUT, SWAMP OAK, DARK ANTHRACITE, WOOD-LIKE ANTHRACITE, RED, BLUE, GREEN, STRUCTURAL BLACK
IN SIZES 80N, 80E, 90N, 90E

NEW !

GLAZED EXTERIOR DOORS

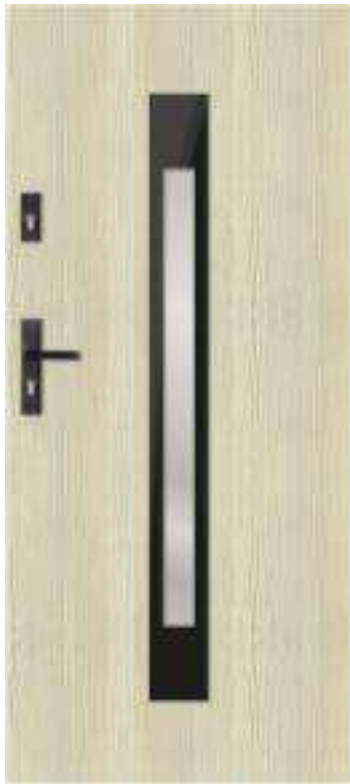

G
S81



T55
S81

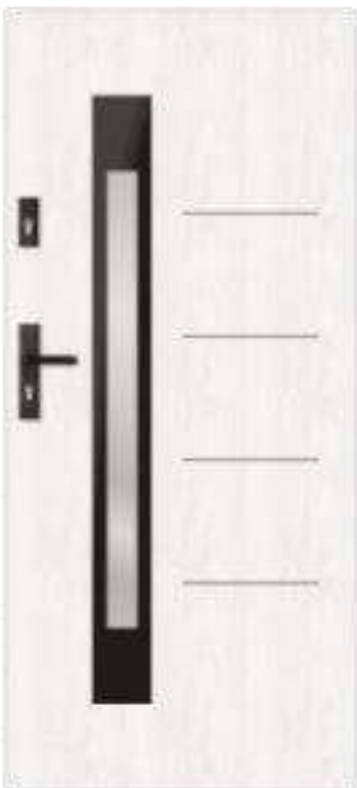

T62
S81







G
S81

STANDARD COLOURS

-  WHITE
-  WHITE WOOD-LIKE
-  LIGHT GREY
-  CONCRETE
-  BLEACHED OAK
-  SONOMA OAK
-  SHEFFIELD OAK
-  WINCHESTER
-  GOLDEN OAK
-  CORTEN
-  DARK WALNUT
-  RUSTIC OAK
-  HORIZONTAL
-  DARK MAHOGANY
-  SWAMP OAK
-  DARK ANTHRACITE
-  WOOD-LIKE ANTHRACITE

NEW !

-  RED
-  BLUE
-  GREEN
-  STRUCTURAL BLACK

EXCLUSIVE COLOURS

-  TURNER OAK
-  BLACKWOOD-LIKE

 DOORS IN SIZES 100N AND 100E AVAILABLE ONLY IN THE INDICATED COLOURS

 COLOURS AVAILABLE WHILE STOCKS LAST

STANDARD COLOURS



EXCLUSIVE COLOURS



DOORS IN SIZES 100N AND 100E
AVAILABLE ONLY IN THE
INDICATED COLOURS

COLOURS AVAILABLE WHILE
STOCKS LAST

GLAZED EXTERIOR DOORS

EMBOSSING T41



AVAILABLE SIZES:
80N, 80E, 90N, 90E, 100N, 100E

SURCHARGE FOR WIDTH 100

85MM THICK DOORS ARE MADE
IN COLOURS: WHITE, TURNER OAK, WINCHESTER,
GOLDEN OAK, DARK WALNUT, SWAMP OAK, DARK ANTHRACITE,
WOOD-LIKE ANTHRACITE, RED, BLUE, GREEN, STRUCTURAL BLACK
IN SIZES 80N, 80E, 90N, 90E

GLAZING S37



FRAMES AVAILABLE IN COLOURS:
INOX AND BLACK

	Ud
55 STANDARD	1,6
55 PREMIUM	1,5
55 PREMIUM PLUS	1,5
72 STANDARD	1,3
72 PREMIUM	1,3
72 PREMIUM PLUS	1,1
72 PREMIUM ALU	0,97
72 PREMIUM H PLUS	1,1
72 PREMIUM H ALU	0,97
85 STANDARD	1,3
85 PREMIUM	1,3
85 PREMIUM PLUS	1,0
85 PREMIUM ALU	0,96
85 PREMIUM H PLUS	1,0
85 PREMIUM H ALU	0,96
72 ECO THERM	0,96
101 MASTER THERM	0,70

GLAZED EXTERIOR DOORS

STANDARD COLOURS



G
S37



T41
S37



T41
S37





G
S37

-  WHITE
-  WHITE WOOD-LIKE
-  LIGHT GREY
-  CONCRETE
-  BLEACHED OAK
-  SONOMA OAK
-  SHEFFIELD OAK
-  WINCHESTER
-  GOLDEN OAK
-  CORTEN
-  DARK WALNUT
-  RUSTIC OAK
-  HORIZONTAL
-  DARK MAHOGANY
-  SWAMP OAK
-  DARK ANTHRACITE
-  WOOD-LIKE ANTHRACITE
- NEW !**
-  RED
-  BLUE
-  GREEN
-  STRUCTURAL BLACK

EXCLUSIVE COLOURS

-  TURNER OAK
-  BLACKWOOD-LIKE

 DOORS IN SIZES 100N AND 100E AVAILABLE ONLY IN THE INDICATED COLOURS

 COLOURS AVAILABLE WHILE STOCKS LAST

STANDARD COLOURS



DOORS IN SIZES 100N AND 100E
AVAILABLE ONLY IN THE
INDICATED COLOURS

COLOURS AVAILABLE WHILE
STOCKS LAST

GLAZED EXTERIOR DOORS

EMBOSSING T52

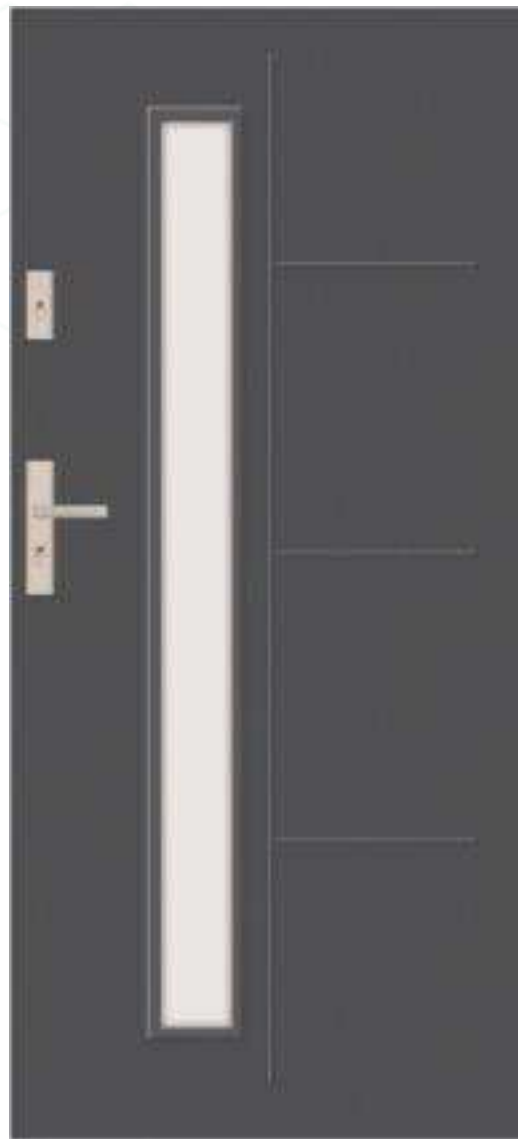

GLAZING S03

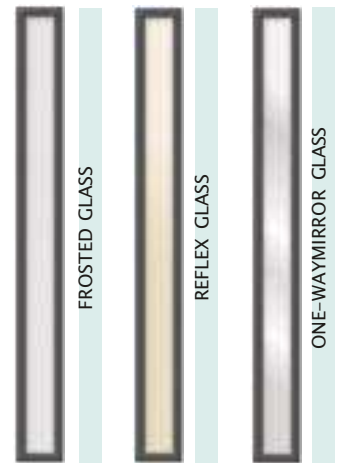

PVC FRAMES IN VENEER COLOURS

	Ud
55 STANDARD	1,6
55 PREMIUM	1,5
55 PREMIUM PLUS	1,5
72 STANDARD	1,3
72 PREMIUM	1,3
72 PREMIUM PLUS	1,1
72 PREMIUM ALU	0,97
72 PREMIUM H PLUS	1,1
72 PREMIUM H ALU	0,97
85 STANDARD	X
85 PREMIUM	X
85 PREMIUM PLUS	X
85 PREMIUM ALU	X
85 PREMIUM H PLUS	X
85 PREMIUM H ALU	X
72 ECO THERM	0,96
101 MASTER THERM	X

AVAILABLE SIZES:

80N, 80E, 90N, 90E, 100N, 100E

SURCHARGE FOR WIDTH 100

GLAZED EXTERIOR DOORS

STANDARD COLOURS



G
S03

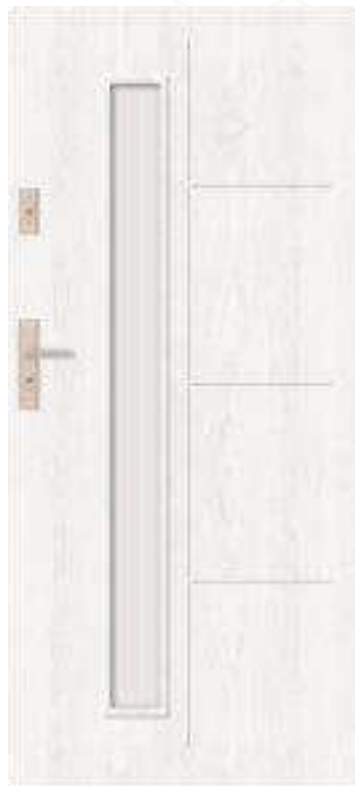

T52
S03



T52
S03



G
S03



WHITE

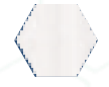

WHITE WOOD-LIKE



WINCHESTER



GOLDEN OAK



DARK WALNUT



RUSTIC OAK



DARK MAHOGANY



SWAMP OAK



DARK ANTHRACITE

* DOORS IN SIZES 100N AND 100E AVAILABLE ONLY IN THE INDICATED COLOURS

** COLOURS AVAILABLE WHILE STOCKS LAST

STANDARD COLOURS

- WHITE 
- WHITE WOOD-LIKE 
- LIGHT GREY 
- CONCRETE 
- BLEACHED OAK 
- SONOMA OAK 
- SHEFFIELD OAK 
- WINCHESTER 
- GOLDEN OAK 
- CORTEN 
- DARK WALNUT 
- RUSTIC OAK 
- HORIZONTAL 
- DARK MAHOGANY 
- SWAMP OAK 
- DARK ANTHRACITE 
- WOOD-LIKE ANTHRACITE 
- NEW !**
- RED 
- BLUE 
- GREEN 
- STRUCTURAL BLACK 

EXCLUSIVE COLOURS

- TURNER OAK 
- BLACKWOOD-LIKE 

DOORS IN SIZES 100N AND 100E AVAILABLE ONLY IN THE INDICATED COLOURS

COLOURS AVAILABLE WHILE STOCKS LAST

GLAZED EXTERIOR DOORS

EMBOSSING T63

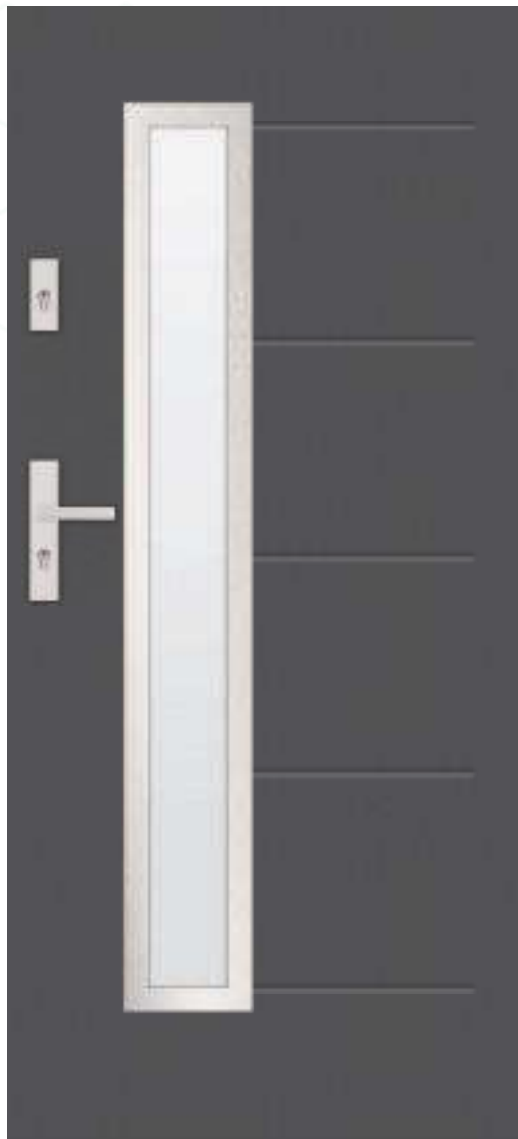

GLAZING S34



FRAMES AVAILABLE IN COLOURS: INOX AND BLACK

	Ud
55 STANDARD	1,6
55 PREMIUM	1,5
55 PREMIUM PLUS	1,5
72 STANDARD	1,3
72 PREMIUM	1,3
72 PREMIUM PLUS	1,1
72 PREMIUM ALU	0,97
72 PREMIUM H PLUS	1,1
72 PREMIUM H ALU	0,97
85 STANDARD	1,3
85 PREMIUM	1,3
85 PREMIUM PLUS	1,0
85 PREMIUM ALU	0,96
85 PREMIUM H PLUS	1,0
85 PREMIUM H ALU	0,96
72 ECO THERM	0,96
101 MASTER THERM	0,70

AVAILABLE SIZES:
80N, 80E, 90N, 90E, 100N, 100E

SURCHARGE FOR WIDTH 100

85MM THICK DOORS ARE MADE
IN COLOURS: WHITE, TURNER OAK, WINCHESTER, GOLDEN OAK, DARK WALNUT, SWAMP OAK, DARK ANTHRACITE, WOOD-LIKE ANTHRACITE, RED, BLUE, GREEN, STRUCTURAL BLACK
IN SIZES 80N, 80E, 90N, 90E

GLAZED EXTERIOR DOORS

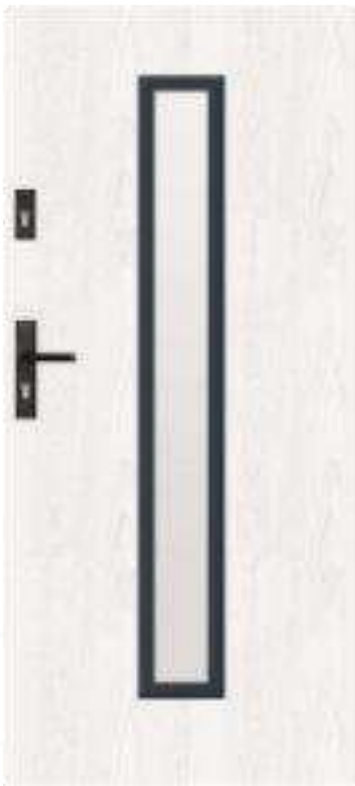

G
S34



T21
S34



T52
S34



T49
S34

STANDARD COLOURS

-  WHITE
-  WHITE WOOD-LIKE
-  LIGHT GREY
-  CONCRETE
-  BLEACHED OAK
-  SONOMA OAK
-  SHEFFIELD OAK
-  WINCHESTER
-  GOLDEN OAK
-  CORTEN
-  DARK WALNUT
-  RUSTIC OAK
-  HORIZONTAL
-  DARK MAHOGANY
-  SWAMP OAK
-  DARK ANTHRACITE
-  WOOD-LIKE ANTHRACITE
- NEW !**
-  RED
-  BLUE
-  GREEN
-  STRUCTURAL BLACK

EXCLUSIVE COLOURS

-  TURNER OAK
-  BLACKWOOD-LIKE

 DOORS IN SIZES 100N AND 100E AVAILABLE ONLY IN THE INDICATED COLOURS

 COLOURS AVAILABLE WHILE STOCKS LAST

STANDARD COLOURS

- WHITE 
- WHITE WOOD-LIKE 
- LIGHT GREY 
- CONCRETE 
- BLEACHED OAK 
- SONOMA OAK 
- SHEFFIELD OAK 
- WINCHESTER 
- GOLDEN OAK 
- CORTEN 
- DARK WALNUT 
- RUSTIC OAK 
- HORIZONTAL 
- DARK MAHOGANY 
- SWAMP OAK 
- DARK ANTHRACITE 
- WOOD-LIKE ANTHRACITE 
- NEW !**
- RED 
- BLUE 
- GREEN 
- STRUCTURAL BLACK 

EXCLUSIVE COLOURS

- TURNER OAK 
- BLACKWOOD-LIKE 

DOORS IN SIZES 100N AND 100E
AVAILABLE ONLY IN THE
INDICATED COLOURS

COLOURS AVAILABLE WHILE
STOCKS LAST

GLAZED EXTERIOR DOORS

EMBOSSING T60



GLAZING S33

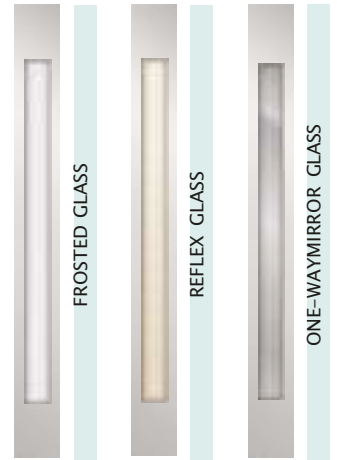

**FRAMES AVAILABLE IN COLOURS:
INOX AND BLACK**

	Ud
55 STANDARD	1,6
55 PREMIUM	1,5
55 PREMIUM PLUS	1,5
72 STANDARD	1,3
72 PREMIUM	1,3
72 PREMIUM PLUS	1,1
72 PREMIUM ALU	0,97
72 PREMIUM H PLUS	1,1
72 PREMIUM H ALU	0,97
85 STANDARD	1,3
85 PREMIUM	1,3
85 PREMIUM PLUS	1,0
85 PREMIUM ALU	0,96
85 PREMIUM H PLUS	1,0
85 PREMIUM H ALU	0,96
72 ECO THERM	0,96
101 MASTER THERM	0,70

AVAILABLE SIZES:
80N, 80E, 90N, 90E, 100N, 100E

SURCHARGE FOR WIDTH 100

**85MM THICK DOORS ARE MADE
IN COLOURS: WHITE, TURNER OAK, WINCHESTER,
GOLDEN OAK, DARK WALNUT, SWAMP OAK, DARK ANTHRACITE,
WOOD-LIKE ANTHRACITE, RED, BLUE, GREEN, STRUCTURAL BLACK
IN SIZES 80N, 80E, 90N, 90E**

GLAZED EXTERIOR DOORS



G
S33



T21
S33



T60
S33



T61
S33

STANDARD COLOURS

-  WHITE
-  WHITE WOOD-LIKE
-  LIGHT GREY
-  CONCRETE
-  BLEACHED OAK
-  SONOMA OAK
-  SHEFFIELD OAK
-  WINCHESTER
-  GOLDEN OAK
-  CORTEN
-  DARK WALNUT
-  RUSTIC OAK
-  HORIZONTAL
-  DARK MAHOGANY
-  SWAMP OAK
-  DARK ANTHRACITE
-  WOOD-LIKE ANTHRACITE
- NEW !**
-  RED
-  BLUE
-  GREEN
-  STRUCTURAL BLACK

EXCLUSIVE COLOURS

-  TURNER OAK
-  BLACKWOOD-LIKE

 DOORS IN SIZES 100N AND 100E AVAILABLE ONLY IN THE INDICATED COLOURS

 COLOURS AVAILABLE WHILE STOCKS LAST

STANDARD COLOURS

- WHITE 
- WHITE WOOD-LIKE 
- LIGHT GREY 
- CONCRETE 
- BLEACHED OAK 
- SONOMA OAK 
- SHEFFIELD OAK 
- WINCHESTER 
- GOLDEN OAK 
- CORTEN 
- DARK WALNUT 
- RUSTIC OAK 
- HORIZONTAL 
- DARK MAHOGANY 
- SWAMP OAK 
- DARK ANTHRACITE 
- WOOD-LIKE ANTHRACITE 
- NEW !**
- RED 
- BLUE 
- GREEN 
- STRUCTURAL BLACK 

EXCLUSIVE COLOURS

- TURNER OAK 
- BLACKWOOD-LIKE 

DOORS IN SIZES 100N AND 100E
AVAILABLE ONLY IN THE
INDICATED COLOURS

COLOURS AVAILABLE WHILE
STOCKS LAST

GLAZED EXTERIOR DOORS

EMBOSSING T41

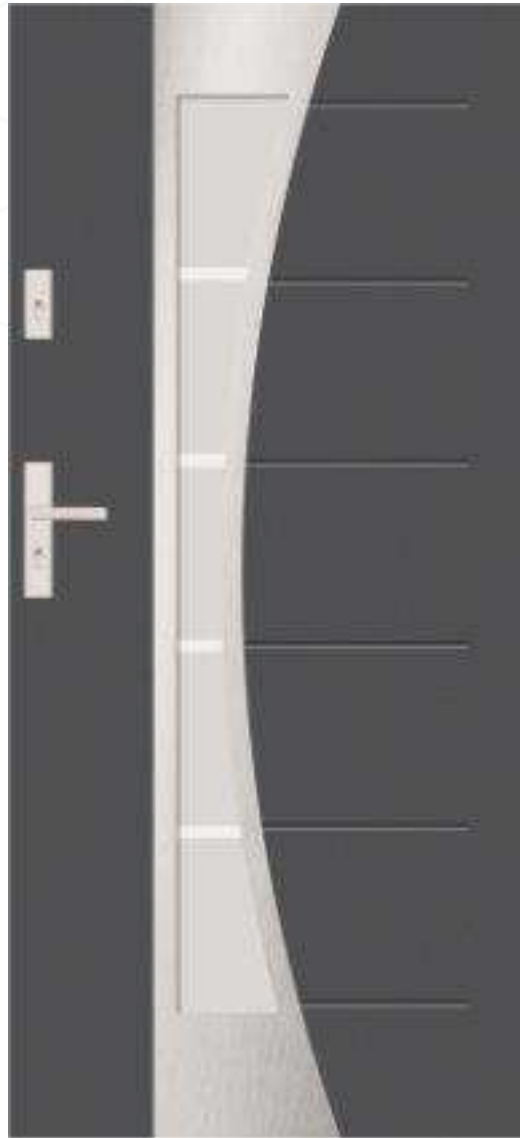

GLAZING S43

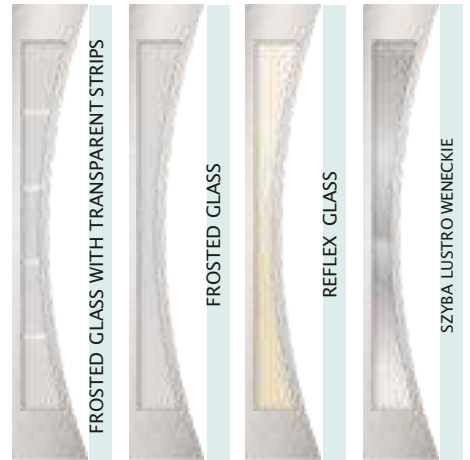

**FRAMES AVAILABLE IN COLOURS:
INOX AND BLACK**

	Ud
55 STANDARD	1,6
55 PREMIUM	1,5
55 PREMIUM PLUS	1,5
72 STANDARD	1,3
72 PREMIUM	1,3
72 PREMIUM PLUS	1,1
72 PREMIUM ALU	0,97
72 PREMIUM H PLUS	1,1
72 PREMIUM H ALU	0,97
85 STANDARD	1,3
85 PREMIUM	1,3
85 PREMIUM PLUS	1,0
85 PREMIUM ALU	0,96
85 PREMIUM H PLUS	1,0
85 PREMIUM H ALU	0,96
72 ECO THERM	0,96
101 MASTER THERM	0,70

AVAILABLE SIZES:
80N, 80E, 90N, 90E, 100N, 100E

SURCHARGE FOR WIDTH 10

**85MM THICK DOORS ARE MADE
IN COLOURS: WHITE, TURNER OAK, WINCHESTER,
GOLDEN OAK, DARK WALNUT, SWAMP OAK, DARK ANTHRACITE,
WOOD-LIKE ANTHRACITE, RED, BLUE, GREEN, STRUCTURAL BLACK
IN SIZES 80N, 80E, 90N, 90E**

GLAZED EXTERIOR DOORS

STANDARD COLOURS

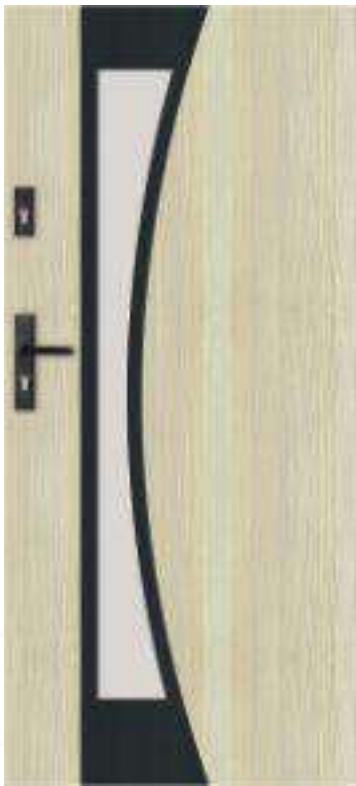

G
S43



T59
S43



T59
S43





T41
S43

-  WHITE
-  WHITE WOOD-LIKE
-  LIGHT GREY
-  CONCRETE
-  BLEACHED OAK
-  SONOMA OAK
-  SHEFFIELD OAK
-  WINCHESTER
-  GOLDEN OAK
-  CORTEN
-  DARK WALNUT
-  RUSTIC OAK
-  HORIZONTAL
-  DARK MAHOGANY
-  SWAMP OAK
-  DARK ANTHRACITE
-  WOOD-LIKE ANTHRACITE
- NEW !**
-  RED
-  BLUE
-  GREEN
-  STRUCTURAL BLACK

EXCLUSIVE COLOURS

-  TURNER OAK
-  BLACKWOOD-LIKE

 DOORS IN SIZES 100N AND 100E AVAILABLE ONLY IN THE INDICATED COLOURS

 COLOURS AVAILABLE WHILE STOCKS LAST

STANDARD COLOURS

- WHITE 
- WHITE WOOD-LIKE 
- LIGHT GREY 
- CONCRETE 
- BLEACHED OAK 
- SONOMA OAK 
- SHEFFIELD OAK 
- WINCHESTER 
- GOLDEN OAK 
- CORTEN 
- DARK WALNUT 
- RUSTIC OAK 
- HORIZONTAL 
- DARK MAHOGANY 
- SWAMP OAK 
- DARK ANTHRACITE 
- WOOD-LIKE ANTHRACITE 
- NEW !**
- RED 
- BLUE 
- GREEN 
- STRUCTURAL BLACK 

EXCLUSIVE COLOURS

- TURNER OAK 
- BLACKWOOD-LIKE 

DOORS IN SIZES 100N AND 100E
AVAILABLE ONLY IN THE
INDICATED COLOURS

COLOURS AVAILABLE WHILE
STOCKS LAST

GLAZED EXTERIOR DOORS

EMBOSSING T60

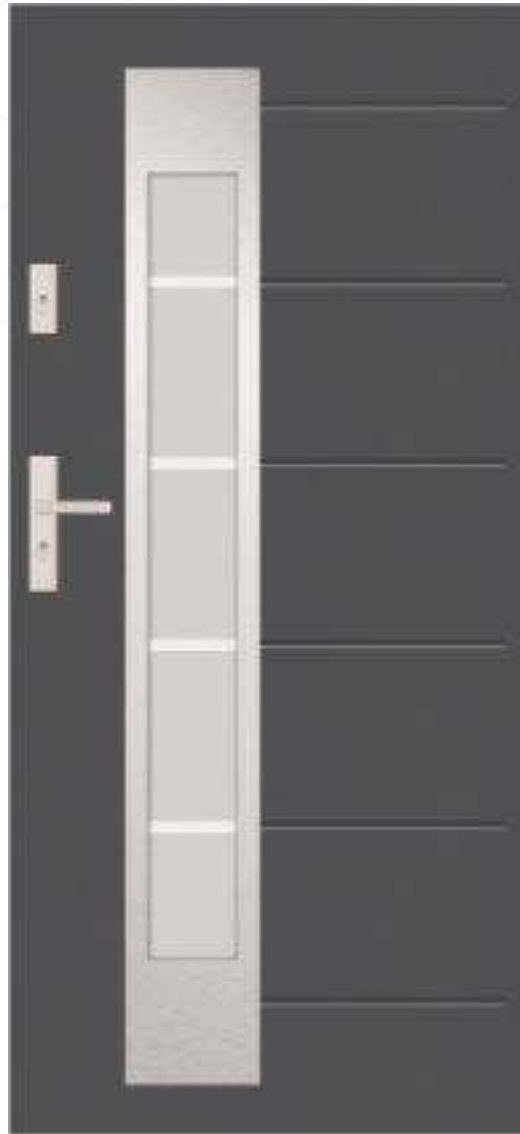

AVAILABLE SIZES:
80N, 80E, 90N, 90E, 100N, 100E

SURCHARGE FOR WIDTH 100

GLAZING S50

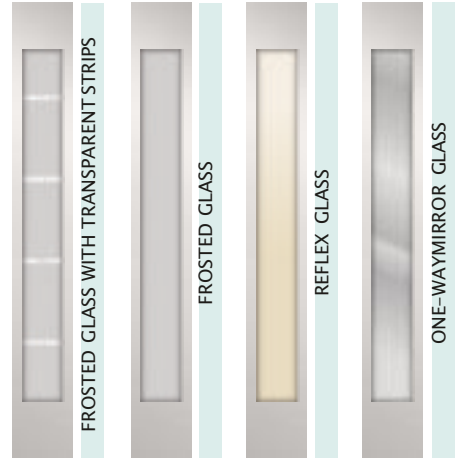

**FRAMES AVAILABLE IN COLOURS:
INOX AND BLACK**

	Ud
55 STANDARD	1,6
55 PREMIUM	1,5
55 PREMIUM PLUS	1,5
72 STANDARD	1,3
72 PREMIUM	1,3
72 PREMIUM PLUS	1,1
72 PREMIUM ALU	0,97
72 PREMIUM H PLUS	1,1
72 PREMIUM H ALU	0,97
85 STANDARD	X
85 PREMIUM	X
85 PREMIUM PLUS	X
85 PREMIUM ALU	X
85 PREMIUM H PLUS	X
85 PREMIUM H ALU	X
72 ECO THERM	0,96
101 MASTER THERM	X

GLAZED EXTERIOR DOORS



G
S50



T60
S50



G
S50



T60
S50

STANDARD COLOURS

-  WHITE
-  WHITE WOOD-LIKE
-  LIGHT GREY
-  CONCRETE
-  BLEACHED OAK
-  SONOMA OAK
-  SHEFFIELD OAK
-  WINCHESTER
-  GOLDEN OAK
-  CORTEN
-  DARK WALNUT
-  RUSTIC OAK
-  HORIZONTAL
-  DARK MAHOGANY
-  SWAMP OAK
-  DARK ANTHRACITE
-  WOOD-LIKE ANTHRACITE
- NEW !**
-  RED
-  BLUE
-  GREEN
-  STRUCTURAL BLACK

EXCLUSIVE COLOURS

-  TURNER OAK
-  BLACKWOOD-LIKE

 DOORS IN SIZES 100N AND 100E AVAILABLE ONLY IN THE INDICATED COLOURS

 COLOURS AVAILABLE WHILE STOCKS LAST

STANDARD COLOURS

- WHITE 
- WHITE WOOD-LIKE 
- LIGHT GREY 
- CONCRETE 
- BLEACHED OAK 
- SONOMA OAK 
- SHEFFIELD OAK 
- WINCHESTER 
- GOLDEN OAK 
- CORTEN 
- DARK WALNUT 
- RUSTIC OAK 
- HORIZONTAL 
- DARK MAHOGANY 
- SWAMP OAK 
- DARK ANTHRACITE 
- WOOD-LIKE ANTHRACITE 
- NEW !**
- RED 
- BLUE 
- GREEN 
- STRUCTURAL BLACK 

EXCLUSIVE COLOURS

- TURNER OAK 
- BLACKWOOD-LIKE 

DOORS IN SIZES 100N AND 100E
AVAILABLE ONLY IN THE
INDICATED COLOURS

COLOURS AVAILABLE WHILE
STOCKS LAST

GLAZED EXTERIOR DOORS

EMBOSSING T52

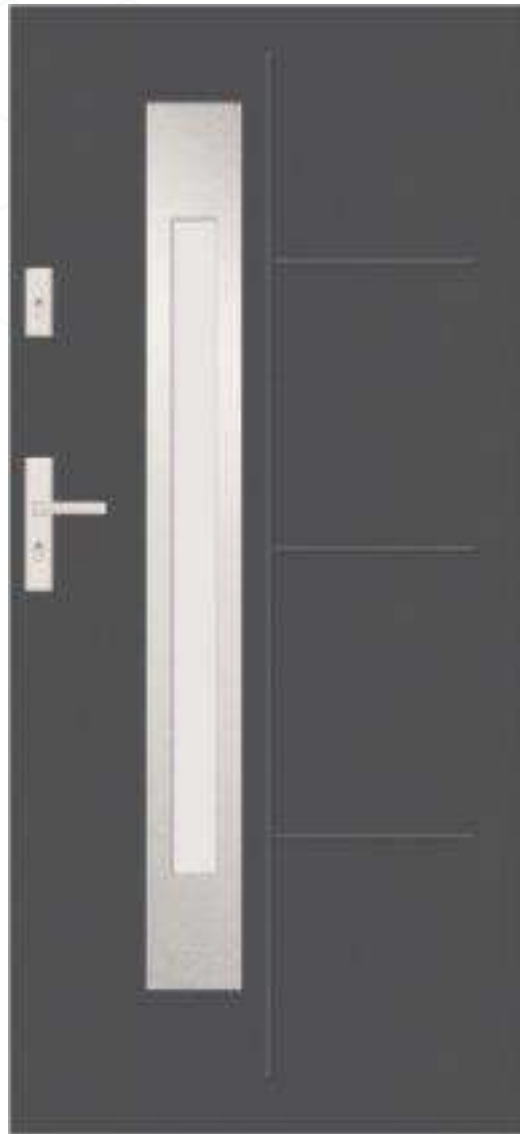

GLAZING S53

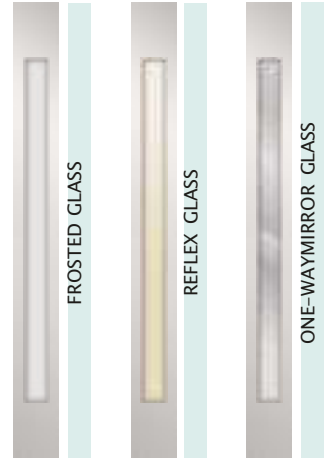

**FRAMES AVAILABLE IN COLOURS:
INOX AND BLACK**

	Ud
55 STANDARD	1,6
55 PREMIUM	1,5
55 PREMIUM PLUS	1,5
72 STANDARD	1,3
72 PREMIUM	1,3
72 PREMIUM PLUS	1,1
72 PREMIUM ALU	0,97
72 PREMIUM H PLUS	1,1
72 PREMIUM H ALU	0,97
85 STANDARD	X
85 PREMIUM	X
85 PREMIUM PLUS	X
85 PREMIUM ALU	X
85 PREMIUM H PLUS	X
85 PREMIUM H ALU	X
72 ECO THERM	0,96
101 MASTER THERM	X

AVAILABLE SIZES:
80N, 80E, 90N, 90E, 100N, 100E

SURCHARGE FOR WIDTH 100

GLAZED EXTERIOR DOORS

STANDARD COLOURS



G
S53



T62
S53



T52
S53





T62
S53

-  WHITE
-  WHITE WOOD-LIKE
-  LIGHT GREY
-  CONCRETE
-  BLEACHED OAK
-  SONOMA OAK
-  SHEFFIELD OAK
-  WINCHESTER
-  GOLDEN OAK
-  CORTEN
-  DARK WALNUT
-  RUSTIC OAK
-  HORIZONTAL
-  DARK MAHOGANY
-  SWAMP OAK
-  DARK ANTHRACITE
-  WOOD-LIKE ANTHRACITE
- NEW !**
-  RED
-  BLUE
-  GREEN
-  STRUCTURAL BLACK

EXCLUSIVE COLOURS

-  TURNER OAK
-  BLACKWOOD-LIKE

 DOORS IN SIZES 100N AND 100E AVAILABLE ONLY IN THE INDICATED COLOURS

 COLOURS AVAILABLE WHILE STOCKS LAST

STANDARD COLOURS

- WHITE 
- WHITE WOOD-LIKE 
- LIGHT GREY 
- CONCRETE 
- BLEACHED OAK 
- SONOMA OAK 
- SHEFFIELD OAK 
- WINCHESTER 
- GOLDEN OAK 
- CORTEN 
- DARK WALNUT 
- RUSTIC OAK 
- HORIZONTAL 
- DARK MAHOGANY 
- SWAMP OAK 
- DARK ANTHRACITE 
- WOOD-LIKE ANTHRACITE 
- NEW !**
- RED 
- BLUE 
- GREEN 
- STRUCTURAL BLACK 

EXCLUSIVE COLOURS

- TURNER OAK 
- BLACKWOOD-LIKE 

DOORS IN SIZES 100N AND 100E
AVAILABLE ONLY IN THE
INDICATED COLOURS

COLOURS AVAILABLE WHILE
STOCKS LAST

GLAZED EXTERIOR DOORS

EMBOSSING T53



AVAILABLE SIZES:
80N, 80E, 90N, 90E, 100N, 100E

SURCHARGE FOR WIDTH 100

**85MM THICK DOORS ARE MADE
IN COLOURS: WHITE, TURNER OAK, WINCHESTER,
GOLDEN OAK, DARK WALNUT, SWAMP OAK, DARK ANTHRACITE,
WOOD-LIKE ANTHRACITE, RED, BLUE, GREEN, STRUCTURAL BLACK
IN SIZES 80N, 80E, 90N, 90E**

GLAZING S60

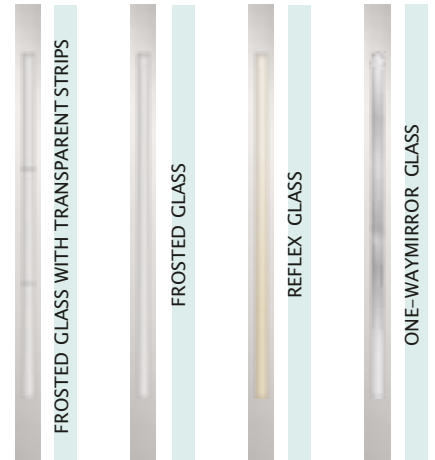

**FRAMES AVAILABLE IN COLOURS:
INOX AND BLACK**

	Ud
55 STANDARD	1,6
55 PREMIUM	1,5
55 PREMIUM PLUS	1,5
72 STANDARD	1,3
72 PREMIUM	1,3
72 PREMIUM PLUS	1,1
72 PREMIUM ALU	0,97
72 PREMIUM H PLUS	1,1
72 PREMIUM H ALU	0,97
85 STANDARD	1,3
85 PREMIUM	1,3
85 PREMIUM PLUS	1,0
85 PREMIUM ALU	0,96
85 PREMIUM H PLUS	1,0
85 PREMIUM H ALU	0,96
72 ECOTHERM	0,96
101 MASTER THERM	X

GLAZED EXTERIOR DOORS

STANDARD COLOURS

-  WHITE
-  WHITE WOOD-LIKE
-  LIGHT GREY
-  CONCRETE
-  BLEACHED OAK
-  SONOMA OAK
-  SHEFFIELD OAK
-  WINCHESTER
-  GOLDEN OAK
-  CORTEN
-  DARK WALNUT
-  RUSTIC OAK
-  HORIZONTAL
-  DARK MAHOGANY
-  SWAMP OAK
-  DARK ANTHRACITE
-  WOOD-LIKE ANTHRACITE
- NEW !**
-  RED
-  BLUE
-  GREEN
-  STRUCTURAL BLACK

EXCLUSIVE COLOURS

-  TURNER OAK
-  BLACKWOOD-LIKE

 DOORS IN SIZES 100N AND 100E AVAILABLE ONLY IN THE INDICATED COLOURS

 COLOURS AVAILABLE WHILE STOCKS LAST



G
S60



T53
S60



G
S60



T53
S60

STANDARD COLOURS

- WHITE 
- WHITE WOOD-LIKE 
- LIGHT GREY 
- CONCRETE 
- BLEACHED OAK 
- SONOMA OAK 
- SHEFFIELD OAK 
- WINCHESTER 
- GOLDEN OAK 
- CORTEN 
- DARK WALNUT 
- RUSTIC OAK 
- HORIZONTAL 
- DARK MAHOGANY 
- SWAMP OAK 
- DARK ANTHRACITE 
- WOOD-LIKE ANTHRACITE 
- NEW !**
- RED 
- BLUE 
- GREEN 
- STRUCTURAL BLACK 

EXCLUSIVE COLOURS

- TURNER OAK 
- BLACKWOOD-LIKE 

DOORS IN SIZES 100N AND 100E AVAILABLE ONLY IN THE INDICATED COLOURS

COLOURS AVAILABLE WHILE STOCKS LAST

GLAZED EXTERIOR DOORS

EMBOSSING T54

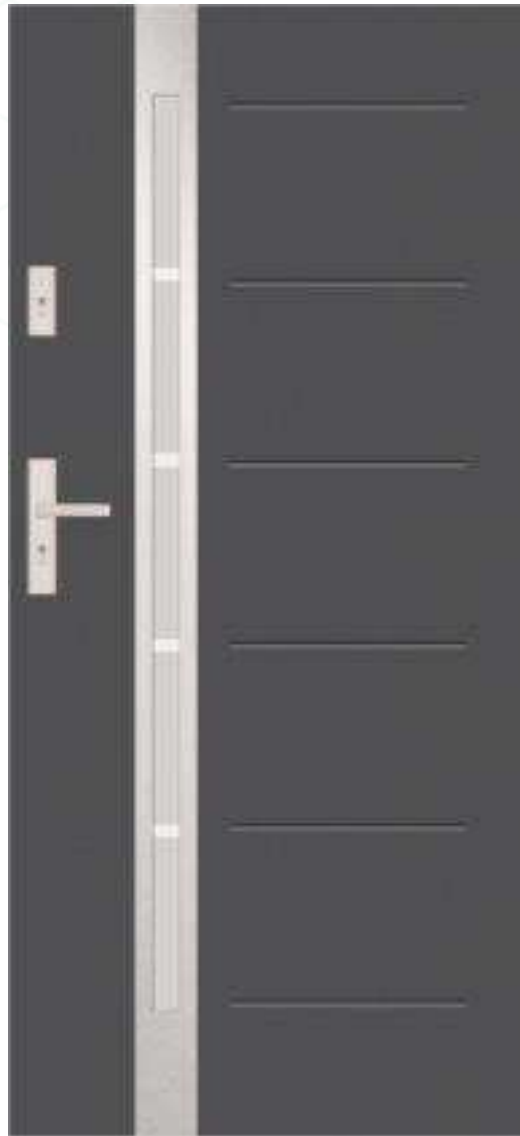

GLAZING S61

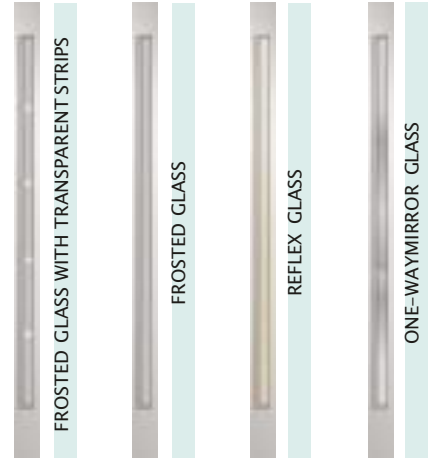

FRAMES AVAILABLE IN COLOURS: INOX AND BLACK

	Ud
55 STANDARD	1,6
55 PREMIUM	1,5
55 PREMIUM PLUS	1,5
72 STANDARD	1,3
72 PREMIUM	1,3
72 PREMIUM PLUS	1,1
72 PREMIUM ALU	0,97
72 PREMIUM H PLUS	1,1
72 PREMIUM H ALU	0,97
85 STANDARD	1,3
85 PREMIUM	1,3
85 PREMIUM PLUS	1,0
85 PREMIUM ALU	0,96
85 PREMIUM H PLUS	1,0
85 PREMIUM H ALU	0,96
72 ECO THERM	0,96
101 MASTER THERM	X

AVAILABLE SIZES:
80N, 80E, 90N, 90E, 100N, 100E

SURCHARGE FOR WIDTH 100

85MM THICK DOORS ARE MADE
IN COLOURS: WHITE, TURNER OAK, WINCHESTER, GOLDEN OAK, DARK WALNUT, SWAMP OAK, DARK ANTHRACITE, WOOD-LIKE ANTHRACITE, RED, BLUE, GREEN, STRUCTURAL BLACK
IN SIZES 80N, 80E, 90N, 90E

GLAZED EXTERIOR DOORS

STANDARD COLOURS



G
S61

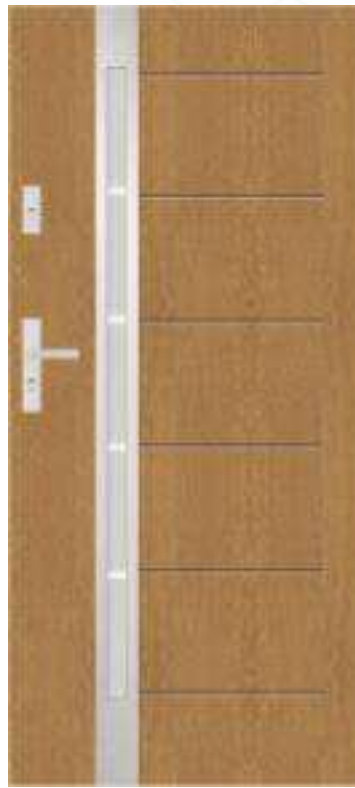

T41
S61



T54
S61

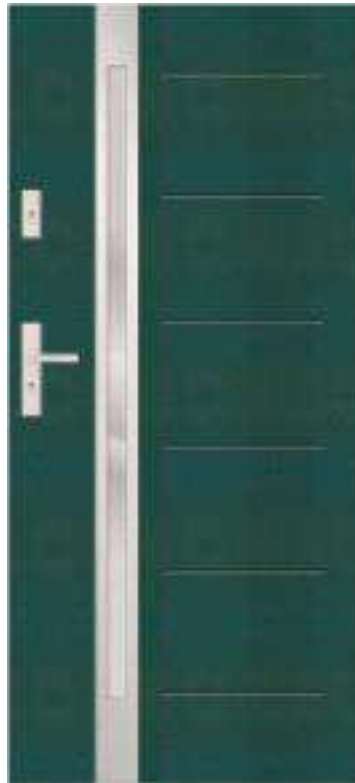



T41
S61

-  WHITE
-  WHITE WOOD-LIKE
-  LIGHT GREY
-  CONCRETE
-  BLEACHED OAK
-  SONOMA OAK
-  SHEFFIELD OAK
-  WINCHESTER
-  GOLDEN OAK
-  CORTEN
-  DARK WALNUT
-  RUSTIC OAK
-  HORIZONTAL
-  DARK MAHOGANY
-  SWAMP OAK
-  DARK ANTHRACITE
-  WOOD-LIKE ANTHRACITE
- NEW !**
-  RED
-  BLUE
-  GREEN
-  STRUCTURAL BLACK

EXCLUSIVE COLOURS

-  TURNER OAK
-  BLACKWOOD-LIKE

 DOORS IN SIZES 100N AND 100E AVAILABLE ONLY IN THE INDICATED COLOURS

 COLOURS AVAILABLE WHILE STOCKS LAST

STANDARD COLOURS



DOORS IN SIZES 100N AND 100E
AVAILABLE ONLY IN THE
INDICATED COLOURS

COLOURS AVAILABLE WHILE
STOCKS LAST

GLAZED EXTERIOR DOORS

EMBOSSING T20



GLAZING

S16

S17

S18



PVC FRAMES IN VENEER COLOURS

	Ud
55 STANDARD	1,6
55 PREMIUM	1,5
55 PREMIUM PLUS	1,5
72 STANDARD	1,3
72 PREMIUM	1,3
72 PREMIUM PLUS	1,1
72 PREMIUM ALU	0,97
72 PREMIUM H PLUS	1,1
72 PREMIUM H ALU	0,97
85 STANDARD	X
85 PREMIUM	X
85 PREMIUM PLUS	X
85 PREMIUM ALU	0,96
85 PREMIUM H PLUS	X
85 PREMIUM H ALU	X
72 ECO THERM	0,96
101 MASTER THERM	X

AVAILABLE SIZES:
80N, 80E, 90N, 90E, 100N, 100E

SURCHARGE FOR WIDTH 100

GLAZED EXTERIOR DOORS

STANDARD COLOURS



G
S16

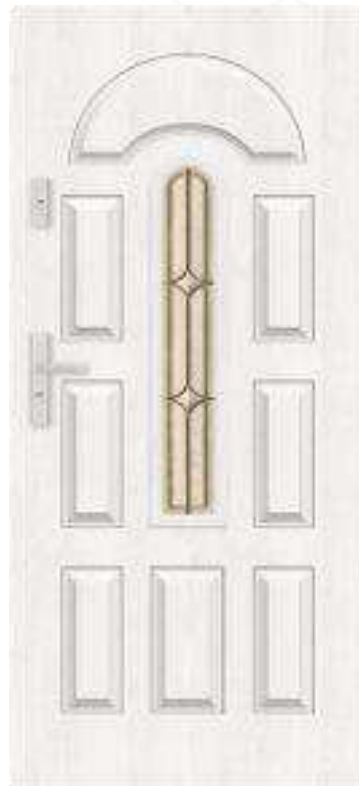

T20
S17



T26
S16



T29
S18



WHITE



WHITE WOOD-LIKE



WINCHESTER



GOLDEN OAK



DARK WALNUT



RUSTIC OAK



DARK MAHOGANY



SWAMP OAK



DARK ANTHRACITE

* DOORS IN SIZES 100N AND 100E
AVAILABLE ONLY IN THE
INDICATED COLOURS

** COLOURS AVAILABLE WHILE
STOCKS LAST

STANDARD COLOURS



WHITE



WHITE WOOD-LIKE



WINCHESTER



GOLDEN OAK



DARK WALNUT



RUSTIC OAK



DARK MAHOGANY



SWAMP OAK



DARK ANTHRACITE

DOORS IN SIZES 100N AND 100E
AVAILABLE ONLY IN THE
INDICATED COLOURS

COLOURS AVAILABLE WHILE
STOCKS LAST

GLAZED EXTERIOR DOORS

EMBOSSING T26|S07



GLAZING

S06

S07

S08



PVC FRAMES IN VENEER COLOURS

	Ud
55 STANDARD	1,6
55 PREMIUM	1,5
55 PREMIUM PLUS	1,5
72 STANDARD	1,3
72 PREMIUM	1,3
72 PREMIUM PLUS	1,1
72 PREMIUM ALU	0,97
72 PREMIUM H PLUS	1,1
72 PREMIUM H ALU	0,97
85 STANDARD	X
85 PREMIUM	X
85 PREMIUM PLUS	X
85 PREMIUM ALU	0,96
85 PREMIUM H PLUS	X
85 PREMIUM H ALU	X
72 ECO THERM	0,96
101 MASTER THERM	X

AVAILABLE SIZES:

80N, 80E, 90N, 90E, 100N, 100E

SURCHARGE FOR WIDTH 100

GLAZED EXTERIOR DOORS

STANDARD COLOURS



G
S08

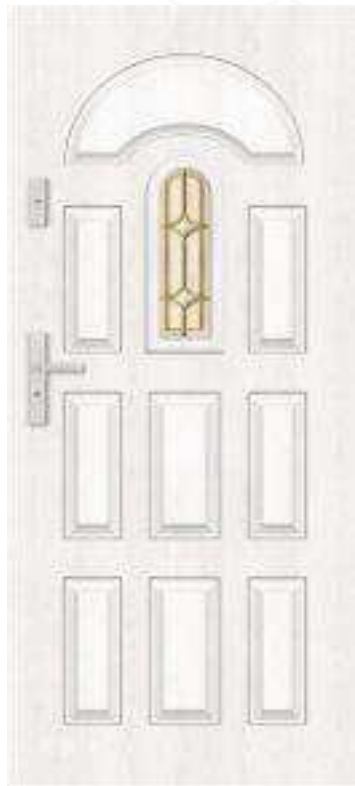

T20
S07



T26
S06



T29
S07



WHITE

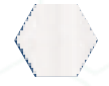

WHITE WOOD-LIKE



WINCHESTER



GOLDEN OAK



DARK WALNUT



RUSTIC OAK



DARK MAHOGANY



SWAMP OAK



DARK ANTHRACITE

* DOORS IN SIZES 100N AND 100E AVAILABLE ONLY IN THE INDICATED COLOURS

* COLOURS AVAILABLE WHILE STOCKS LAST





EXTERIOR DOORS

GLAZED WITH DECORS

STANDARD COLOURS

- WHITE 
- WHITE WOOD-LIKE 
- LIGHT GREY 
- CONCRETE 
- BLEACHED OAK 
- SONOMA OAK 
- SHEFFIELD OAK 
- WINCHESTER 
- GOLDEN OAK 
- CORTEN 
- DARK WALNUT 
- RUSTIC OAK 
- HORIZONTAL 
- DARK MAHOGANY 
- SWAMP OAK 
- DARK ANTHRACITE 
- WOOD-LIKE ANTHRACITE 
- NEW !**
- RED 
- BLUE 
- GREEN 
- STRUCTURAL BLACK 

EXCLUSIVE COLOURS

- TURNER OAK 
- BLACKWOOD-LIKE 

DOORS IN SIZES 100N AND 100E
AVAILABLE ONLY IN THE
INDICATED COLOURS

COLOURS AVAILABLE WHILE
STOCKS LAST

EXTERIOR GLAZED DOORS WITH DECORS

DECOR A46 NARROW



AVAILABLE SIZES:
80N, 80E, 90N, 90E, 100N, 100E

SURCHARGE FOR WIDTH 100

**85MM THICK DOORS ARE MADE
IN COLOURS: WHITE, TURNER OAK, WINCHESTER,
GOLDEN OAK, DARK WALNUT, SWAMP OAK,
DARK ANTHRACITE, WOOD-LIKE ANTHRACITE, RED, BLUE, GREEN, STRUCTURAL BLACK
IN SIZES 80N, 80E, 90N, 90E**

GLAZING S33



**FRAMES AVAILABLE IN COLOURS:
INOX AND BLACK**

DECOR WIDTH:
NARROW DECOR - 14MM
WIDE DECOR - 30MM

	Ud
55 STANDARD	1,6
55 PREMIUM	1,5
55 PREMIUM PLUS	1,5
72 STANDARD	1,3
72 PREMIUM	1,3
72 PREMIUM PLUS	1,1
72 PREMIUM ALU	0,97
72 PREMIUM H PLUS	1,1
72 PREMIUM H ALU	0,97
85 STANDARD	1,3
85 PREMIUM	1,3
85 PREMIUM PLUS	1,0
85 PREMIUM ALU	0,96
85 PREMIUM H PLUS	1,0
85 PREMIUM H ALU	0,96
72 ECO THERM	0,96
101 MASTER THERM	0,70

EXTERIOR GLAZED DOORS WITH DECORS

STANDARD COLOURS

-  WHITE
-  WHITE WOOD-LIKE
-  LIGHT GREY
-  CONCRETE
-  BLEACHED OAK
-  SONOMA OAK
-  SHEFFIELD OAK
-  WINCHESTER
-  GOLDEN OAK
-  CORTEN
-  DARK WALNUT
-  RUSTIC OAK
-  HORIZONTAL
-  DARK MAHOGANY
-  SWAMP OAK
-  DARK ANTHRACITE
-  WOOD-LIKE ANTHRACITE
- NEW !**
-  RED
-  BLUE
-  GREEN
-  STRUCTURAL BLACK

EXCLUSIVE COLOURS

-  TURNER OAK
-  BLACKWOOD-LIKE

 DOORS IN SIZES 100N AND 100E AVAILABLE ONLY IN THE INDICATED COLOURS

 COLOURS AVAILABLE WHILE STOCKS LAST



A46
NARROW
S33



A46
NARROW
S33



A46
NARROW
S33

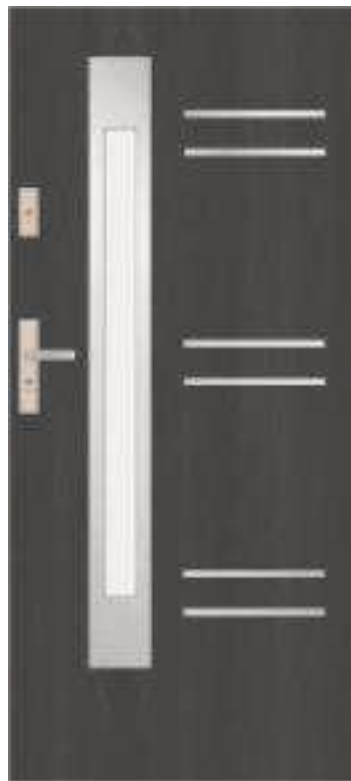

A46
NARROW
S33

STANDARD COLOURS

- WHITE 
- WHITE WOOD-LIKE 
- LIGHT GREY 
- CONCRETE 
- BLEACHED OAK 
- SONOMA OAK 
- SHEFFIELD OAK 
- WINCHESTER 
- GOLDEN OAK 
- CORTEN 
- DARK WALNUT 
- RUSTIC OAK 
- HORIZONTAL 
- DARK MAHOGANY 
- SWAMP OAK 
- DARK ANTHRACITE 
- WOOD-LIKE ANTHRACITE 
- NEW !**
- RED 
- BLUE 
- GREEN 
- STRUCTURAL BLACK 

EXCLUSIVE COLOURS

- TURNER OAK 
- BLACKWOOD-LIKE 

DOORS IN SIZES 100N AND 100E
AVAILABLE ONLY IN THE
INDICATED COLOURS

COLOURS AVAILABLE WHILE
STOCKS LAST

EXTERIOR GLAZED DOORS WITH DECORS

DECOR A41 WIDE

GLAZING S36

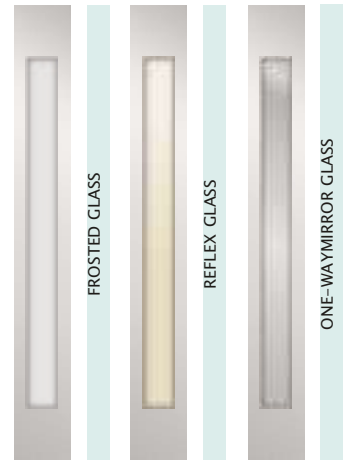
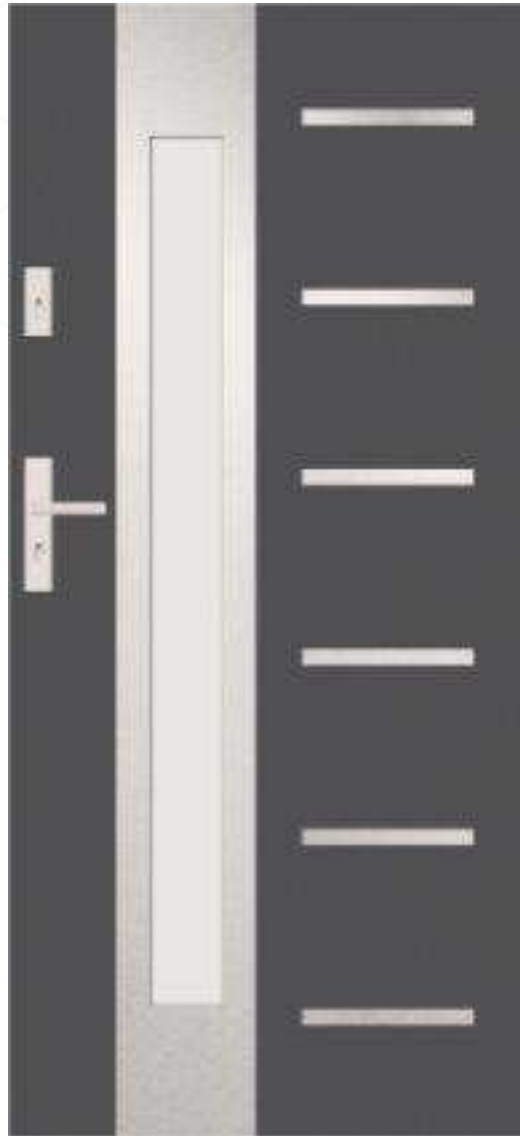

FRAMES AVAILABLE IN COLOURS:
INOX AND BLACK

DECOR WIDTH:
NARROW DECOR - 14MM
WIDE DECOR - 30MM

	Ud
55 STANDARD	1,6
55 PREMIUM	1,5
55 PREMIUM PLUS	1,5
72 STANDARD	1,3
72 PREMIUM	1,3
72 PREMIUM PLUS	1,1
72 PREMIUM ALU	0,97
72 PREMIUM H PLUS	1,1
72 PREMIUM H ALU	0,97
85 STANDARD	1,3
85 PREMIUM	1,3
85 PREMIUM PLUS	1,0
85 PREMIUM ALU	0,96
85 PREMIUM H PLUS	1,0
85 PREMIUM H ALU	0,96
72 ECO THERM	0,96
101 MASTER THERM	0,70

AVAILABLE SIZES:
80N, 80E, 90N, 90E, 100N, 100E

SURCHARGE FOR WIDTH 100

85MM THICK DOORS ARE MADE
IN COLOURS: WHITE, TURNER OAK, WINCHESTER,
GOLDEN OAK, DARK WALNUT, SWAMP OAK,
DARK ANTHRACITE, WOOD-LIKE ANTHRACITE, RED, BLUE, GREEN, STRUCTURAL BLACK
IN SIZES 80N, 80E, 90N, 90E

EXTERIOR GLAZED DOORS WITH DECORS

STANDARD COLOURS

-  WHITE
-  WHITE WOOD-LIKE
-  LIGHT GREY
-  CONCRETE
-  BLEACHED OAK
-  SONOMA OAK
-  SHEFFIELD OAK
-  WINCHESTER
-  GOLDEN OAK
-  CORTEN
-  DARK WALNUT
-  RUSTIC OAK
-  HORIZONTAL
-  DARK MAHOGANY
-  SWAMP OAK
-  DARK ANTHRACITE
-  WOOD-LIKE ANTHRACITE
- NEW !**
-  RED
-  BLUE
-  GREEN
-  STRUCTURAL BLACK

EXCLUSIVE COLOURS

-  TURNER OAK
-  BLACKWOOD-LIKE

 DOORS IN SIZES 100N AND 100E AVAILABLE ONLY IN THE INDICATED COLOURS

 COLOURS AVAILABLE WHILE STOCKS LAST

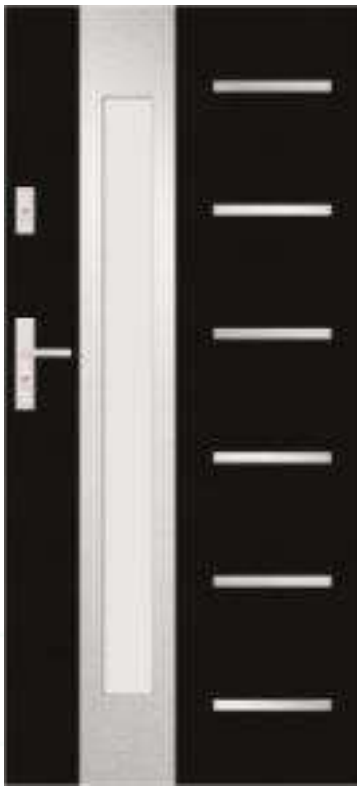

A41
WIDE
S36



A41
WIDE
S36



A41
WIDE
S36



A41
WIDE
S36

STANDARD COLOURS

- WHITE 
- WHITE WOOD-LIKE 
- LIGHT GREY 
- CONCRETE 
- BLEACHED OAK 
- SONOMA OAK 
- SHEFFIELD OAK 
- WINCHESTER 
- GOLDEN OAK 
- CORTEN 
- DARK WALNUT 
- RUSTIC OAK 
- HORIZONTAL 
- DARK MAHOGANY 
- SWAMP OAK 
- DARK ANTHRACITE 
- WOOD-LIKE ANTHRACITE 
- NEW !**
- RED 
- BLUE 
- GREEN 
- STRUCTURAL BLACK 

EXCLUSIVE COLOURS

- TURNER OAK 
- BLACKWOOD-LIKE 

DOORS IN SIZES 100N AND 100E
AVAILABLE ONLY IN THE
INDICATED COLOURS

COLOURS AVAILABLE WHILE
STOCKS LAST

EXTERIOR GLAZED DOORS WITH DECORS

DECOR A53^{NARROW}

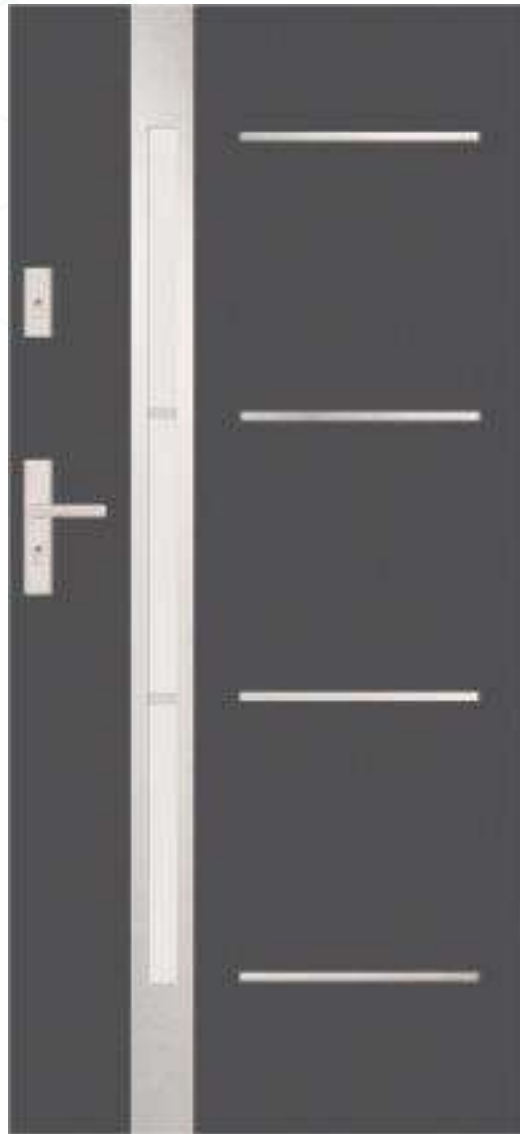

GLAZING S60



**FRAMES AVAILABLE IN COLOURS:
INOX AND BLACK**

**DECOR WIDTH:
NARROW DECOR - 14MM
WIDE DECOR - 30MM**

	Ud
55 STANDARD	1,6
55 PREMIUM	1,5
55 PREMIUM PLUS	1,5
72 STANDARD	1,3
72 PREMIUM	1,3
72 PREMIUM PLUS	1,1
72 PREMIUM ALU	0,97
72 PREMIUM H PLUS	1,1
72 PREMIUM H ALU	0,97
85 STANDARD	1,3
85 PREMIUM	1,3
85 PREMIUM PLUS	1,0
85 PREMIUM ALU	0,96
85 PREMIUM H PLUS	1,0
85 PREMIUM H ALU	0,96
72 ECO THERM	0,96
101 MASTER THERM	X

**AVAILABLE SIZES:
80N, 80E, 90N, 90E, 100N, 100E**

SURCHARGE FOR WIDTH 100

**85MM THICK DOORS ARE MADE
IN COLOURS: WHITE, TURNER OAK, WINCHESTER,
GOLDEN OAK, DARK WALNUT, SWAMP OAK,
DARK ANTHRACITE, WOOD-LIKE ANTHRACITE, RED, BLUE, GREEN, STRUCTURAL BLACK
IN SIZES 80N, 80E, 90N, 90E**

EXTERIOR GLAZED DOORS WITH DECORS

STANDARD COLOURS

-  WHITE
-  WHITE WOOD-LIKE
-  LIGHT GREY
-  CONCRETE
-  BLEACHED OAK
-  SONOMA OAK
-  SHEFFIELD OAK
-  WINCHESTER
-  GOLDEN OAK
-  CORTEN
-  DARK WALNUT
-  RUSTIC OAK
-  HORIZONTAL
-  DARK MAHOGANY
-  SWAMP OAK
-  DARK ANTHRACITE
-  WOOD-LIKE ANTHRACITE
- NEW !**
-  RED
-  BLUE
-  GREEN
-  STRUCTURAL BLACK

EXCLUSIVE COLOURS

-  TURNER OAK
-  BLACKWOOD-LIKE

 DOORS IN SIZES 100N AND 100E AVAILABLE ONLY IN THE INDICATED COLOURS

 COLOURS AVAILABLE WHILE STOCKS LAST



A53
NARROW
S60



A53
NARROW
S60



A53
NARROW
S60

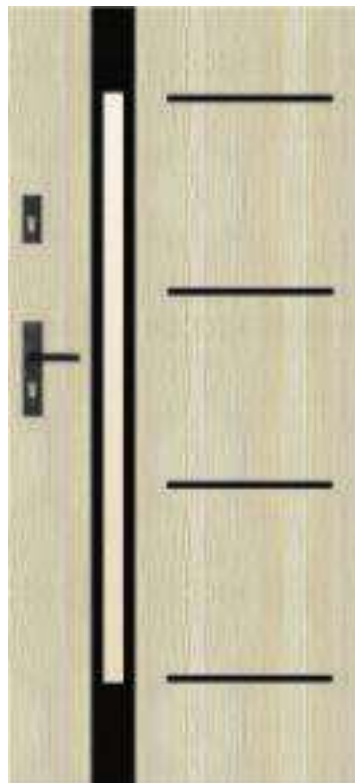

A53
NARROW
S60

STANDARD COLOURS

- WHITE 
- WHITE WOOD-LIKE 
- LIGHT GREY 
- CONCRETE 
- BLEACHED OAK 
- SONOMA OAK 
- SHEFFIELD OAK 
- WINCHESTER 
- GOLDEN OAK 
- CORTEN 
- DARK WALNUT 
- RUSTIC OAK 
- HORIZONTAL 
- DARK MAHOGANY 
- SWAMP OAK 
- DARK ANTHRACITE 
- WOOD-LIKE ANTHRACITE 
- NEW !**
- RED 
- BLUE 
- GREEN 
- STRUCTURAL BLACK 

EXCLUSIVE COLOURS

- TURNER OAK 
- BLACKWOOD-LIKE 

DOORS IN SIZES 100N AND 100E
AVAILABLE ONLY IN THE
INDICATED COLOURS

COLOURS AVAILABLE WHILE
STOCKS LAST

EXTERIOR GLAZED DOORS WITH DECORS

DECOR A49^{NARROW}

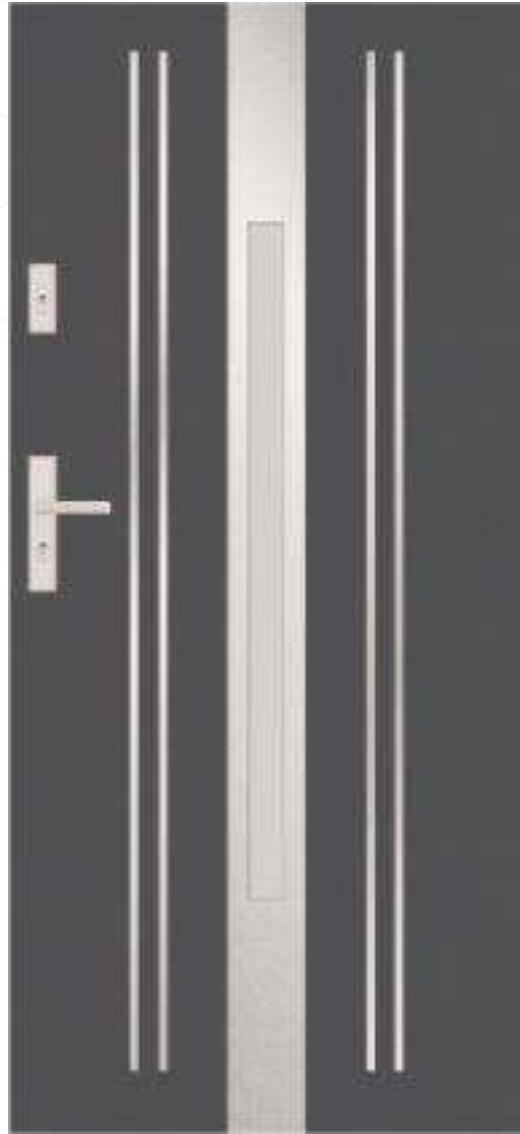

GLAZING S62



**FRAMES AVAILABLE IN COLOURS:
INOX AND BLACK**

**DECOR WIDTH:
NARROW DECOR - 14MM
WIDE DECOR - 30MM**

	Ud
55 STANDARD	1,6
55 PREMIUM	1,5
55 PREMIUM PLUS	1,5
72 STANDARD	1,3
72 PREMIUM	1,3
72 PREMIUM PLUS	1,1
72 PREMIUM ALU	0,97
72 PREMIUM H PLUS	1,1
72 PREMIUM H ALU	0,97
85 STANDARD	1,3
85 PREMIUM	1,3
85 PREMIUM PLUS	1,0
85 PREMIUM ALU	0,96
85 PREMIUM H PLUS	1,0
85 PREMIUM H ALU	0,96
72 ECO THERM	0,96
101 MASTER THERM	X

**AVAILABLE SIZES:
80N, 80E, 90N, 90E, 100N, 100E**

SURCHARGE FOR WIDTH 100

EXTERIOR GLAZED DOORS WITH DECORS

STANDARD COLOURS



A49
NARROW
S62

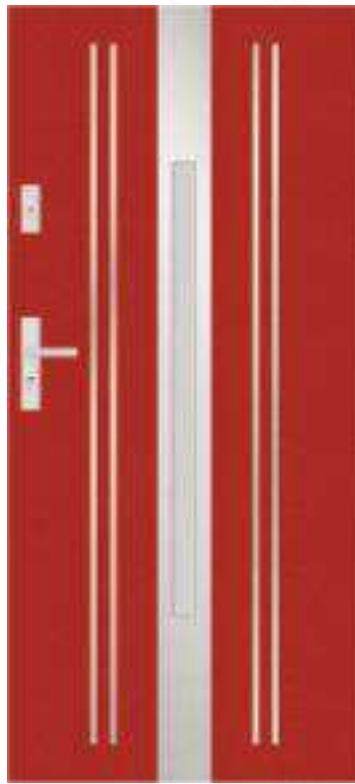

A49
NARROW
S62



A49
NARROW
S62

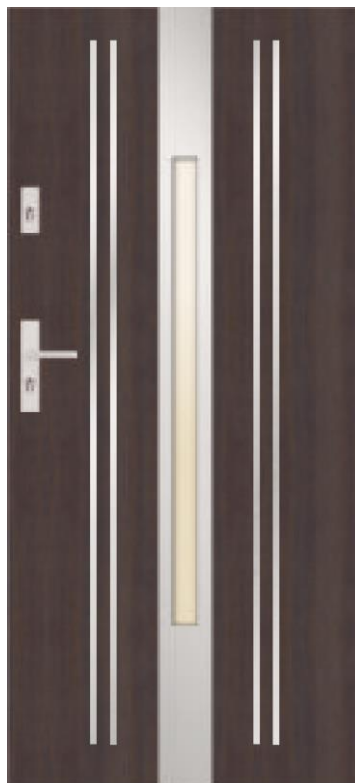



A49
NARROW
S62

-  WHITE
-  WHITE WOOD-LIKE
-  LIGHT GREY
-  CONCRETE
-  BLEACHED OAK
-  SONOMA OAK
-  SHEFFIELD OAK
-  WINCHESTER
-  GOLDEN OAK
-  CORTEN
-  DARK WALNUT
-  RUSTIC OAK
-  HORIZONTAL
-  DARK MAHOGANY
-  SWAMP OAK
-  DARK ANTHRACITE
-  WOOD-LIKE ANTHRACITE
- NEW !**
-  RED
-  BLUE
-  GREEN
-  STRUCTURAL BLACK

EXCLUSIVE COLOURS

-  TURNER OAK
-  BLACKWOOD-LIKE

 DOORS IN SIZES 100N AND 100E AVAILABLE ONLY IN THE INDICATED COLOURS

 COLOURS AVAILABLE WHILE STOCKS LAST





**EXTERIOR DOORS
WITH DECORS**

STANDARD COLOURS

- WHITE 
- WHITE WOOD-LIKE 
- LIGHT GREY 
- CONCRETE 
- BLEACHED OAK 
- SONOMA OAK 
- SHEFFIELD OAK 
- WINCHESTER 
- GOLDEN OAK 
- CORTEN 
- DARK WALNUT 
- RUSTIC OAK 
- HORIZONTAL 
- DARK MAHOGANY 
- SWAMP OAK 
- DARK ANTHRACITE 
- WOOD-LIKE ANTHRACITE 
- NEW !**
- RED 
- BLUE 
- GREEN 
- STRUCTURAL BLACK 

EXCLUSIVE COLOURS

- TURNER OAK 
- BLACKWOOD-LIKE 

DOORS IN SIZES 100N AND 100E
AVAILABLE ONLY IN THE
INDICATED COLOURS

COLOURS AVAILABLE WHILE
STOCKS LAST

EXTERIOR DOORS WITH DECORS



**EMBOSSING T54
DECOR A5**

**DECOR WIDTH:
NARROW DECOR - 14MM
WIDE DECOR - 30MM**

	Ud
55 STANDARD	1,3
55 PREMIUM	1,2
55 PREMIUM PLUS	1,2
72 STANDARD	1,3
72 PREMIUM	1,2
72 PREMIUM PLUS	1,0
72 PREMIUM ALU	0,88
72 PREMIUM H PLUS	1,0
72 PREMIUM H ALU	0,88
85 STANDARD	1,2
85 PREMIUM	1,1
85 PREMIUM PLUS	0,91
85 PREMIUM ALU	0,85
85 PREMIUM H PLUS	0,91
85 PREMIUM H ALU	0,85
72 ECO THERM	0,88
101 MASTER THERM	0,63

**AVAILABLE SIZES:
80N, 80E, 90N, 90E, 100N, 100E**

SURCHARGE FOR WIDTH 100

**85MM THICK DOORS ARE MADE
IN COLOURS: WHITE, TURNER OAK, WINCHESTER,
GOLDEN OAK, DARK WALNUT, SWAMP OAK,
DARK ANTHRACITE, WOOD-LIKE ANTHRACITE, RED, BLUE, GREEN, STRUCTURAL BLACK
IN SIZES 80N, 80E, 90N, 90E**

PRICES ARE GIVEN FOR THE VERSION WITH ONE-SIDED DECOR. WHEN ORDERING A TWO-SIDED VERSION, A SURCHARGE OF PLN 200.00 APPLIES

OTHER DECORS MODELS CAN BE FOUND ON PAGE 151 OF THE CATALOGUE

EXTERIOR DOORS WITH DECORS

STANDARD COLOURS

-  WHITE
-  WHITE WOOD-LIKE
-  LIGHT GREY
-  CONCRETE
-  BLEACHED OAK
-  SONOMA OAK
-  SHEFFIELD OAK
-  WINCHESTER
-  GOLDEN OAK
-  CORTEN
-  DARK WALNUT
-  RUSTIC OAK
-  HORIZONTAL
-  DARK MAHOGANY
-  SWAMP OAK
-  DARK ANTHRACITE
-  WOOD-LIKE ANTHRACITE
- NEW !**
-  RED
-  BLUE
-  GREEN
-  STRUCTURAL BLACK

EXCLUSIVE COLOURS

-  TURNER OAK
-  BLACKWOOD-LIKE

 DOORS IN SIZES 100N AND 100E AVAILABLE ONLY IN THE INDICATED COLOURS

 COLOURS AVAILABLE WHILE STOCKS LAST



T45
A22



T41
A1



T49
A7



T45
A2





EXTERIOR DOORS

FULL

STANDARD COLOURS

WHITE	
WHITE WOOD-LIKE	
LIGHT GREY	
CONCRETE	
BLEACHED OAK	
SONOMA OAK	
SHEFFIELD OAK	
WINCHESTER	
GOLDEN OAK	
CORTEN	
DARK WALNUT	
RUSTIC OAK	
HORIZONTAL	
DARK MAHOGANY	
SWAMP OAK	
DARK ANTHRACITE	
WOOD-LIKE ANTHRACITE	
NEW !	
RED	
BLUE	
GREEN	
STRUCTURAL BLACK	

EXCLUSIVE COLOURS

TURNER OAK	
BLACKWOOD-LIKE	

DOORS IN SIZES 100N AND 100E
AVAILABLE ONLY IN THE
INDICATED COLOURS

COLOURS AVAILABLE WHILE
STOCKS LAST

EXTERIOR FULL DOORS



SMOOTH | G

AVAILABLE SIZES:
80N, 80E, 90N, 90E, 100N, 100E

SURCHARGE FOR WIDTH 100

85MM THICK DOORS ARE MADE
IN COLOURS: WHITE, TURNER OAK, WINCHESTER,
GOLDEN OAK, DARKWALNUT, SWAMP OAK, DARKANTHRACITE,
WOOD-LIKEANTHRACITE, RED, BLUE, GREEN, STRUCTURAL BLACK
IN SIZES 80N, 80E, 90N, 90E

	Ud
55 STANDARD	1,3
55 PREMIUM	1,2
55 PREMIUM PLUS	1,2
72 STANDARD	1,3
72 PREMIUM	1,2
72 PREMIUM PLUS	1,0
72 PREMIUM ALU	0,88
72 PREMIUM H PLUS	1,0
72 PREMIUM H ALU	0,88
85 STANDARD	1,2
85 PREMIUM	1,1
85 PREMIUM PLUS	0,91
85 PREMIUM ALU	0,85
85 PREMIUM H PLUS	0,91
85 PREMIUM H ALU	0,85
72 ECO THERM	0,88
101 MASTER THERM	0,63

EXTERIOR FULL DOORS

STANDARD COLOURS



WHITE



WHITE WOOD-LIKE



LIGHT GREY



BLEACHED OAK



SONOMA OAK



SHEFFIELD OAK



WINCHESTER



GOLDEN OAK



DARK WALNUT



RUSTIC OAK



DARK MAHOGANY



SWAMP OAK



DARK ANTHRACITE



WOOD-LIKE ANTHRACITE

EXCLUSIVE COLOURS



TURNER OAK



DOORS IN SIZES 100N AND 100E AVAILABLE ONLY IN THE INDICATED COLOURS



COLOURS AVAILABLE WHILE STOCKS LAST



T20



T21



T26



T29

STANDARD COLOURS

WHITE	
WHITE WOOD-LIKE	
LIGHT GREY	
CONCRETE	
BLEACHED OAK	
SONOMA OAK	
SHEFFIELD OAK	
WINCHESTER	
GOLDEN OAK	
CORTEN	
DARK WALNUT	
RUSTIC OAK	
HORIZONTAL	
DARK MAHOGANY	
SWAMP OAK	
DARK ANTHRACITE	
WOOD-LIKE ANTHRACITE	
NEW !	
RED	
BLUE	
GREEN	
STRUCTURAL BLACK	

EXCLUSIVE COLOURS

TURNER OAK	
BLACKWOOD-LIKE	

DOORS IN SIZES 100N AND 100E
AVAILABLE ONLY IN THE
INDICATED COLOURS

COLOURS AVAILABLE WHILE
STOCKS LAST

EXTERIOR FULL DOORS



EMBOSSING T41

AVAILABLE SIZES:

80N, 80E, 90N, 90E, 100N, 100E

SURCHARGE FOR WIDTH 100

85MM THICK DOORS ARE MADE

IN COLOURS: WHITE, TURNER OAK, WINCHESTER,
GOLDEN OAK, DARK WALNUT, SWAMP OAK, DARK ANTHRACITE,
WOOD-LIKE ANTHRACITE, RED, BLUE, GREEN, STRUCTURAL BLACK
IN SIZES 80N, 80E, 90N, 90E

	Ud
55 STANDARD	1,3
55 PREMIUM	1,2
55 PREMIUM PLUS	1,2
72 STANDARD	1,3
72 PREMIUM	1,2
72 PREMIUM PLUS	1,0
72 PREMIUM ALU	0,88
72 PREMIUM H PLUS	1,0
72 PREMIUM H ALU	0,88
85 STANDARD	1,2
85 PREMIUM	1,1
85 PREMIUM PLUS	0,91
85 PREMIUM ALU	0,85
85 PREMIUM H PLUS	0,91
85 PREMIUM H ALU	0,85
72 ECO THERM	0,88
101 MASTER THERM	0,63

EXTERIOR FULL DOORS

STANDARD COLOURS

-  WHITE
-  WHITE WOOD-LIKE
-  LIGHT GREY
-  CONCRETE
-  BLEACHED OAK
-  SONOMA OAK
-  SHEFFIELD OAK
-  WINCHESTER
-  GOLDEN OAK
-  CORTEN
-  DARK WALNUT
-  RUSTIC OAK
-  HORIZONTAL
-  DARK MAHOGANY
-  SWAMP OAK
-  DARK ANTHRACITE
-  WOOD-LIKE ANTHRACITE
- NEW !**
-  RED
-  BLUE
-  GREEN
-  STRUCTURAL BLACK

EXCLUSIVE COLOURS

-  TURNER OAK
-  BLACKWOOD-LIKE

 DOORS IN SIZES 100N AND 100E AVAILABLE ONLY IN THE INDICATED COLOURS

 COLOURS AVAILABLE WHILE STOCKS LAST



T42



T43



T44



T45

STANDARD COLOURS

- WHITE 
- WHITE WOOD-LIKE 
- LIGHT GREY 
- CONCRETE 
- BLEACHED OAK 
- SONOMA OAK 
- SHEFFIELD OAK 
- WINCHESTER 
- GOLDEN OAK 
- CORTEN 
- DARK WALNUT 
- RUSTIC OAK 
- HORIZONTAL 
- DARK MAHOGANY 
- SWAMP OAK 
- DARK ANTHRACITE 
- WOOD-LIKE ANTHRACITE 
- NEW !**
- RED 
- BLUE 
- GREEN 
- STRUCTURAL BLACK 

EXCLUSIVE COLOURS

- TURNER OAK 
- BLACKWOOD-LIKE 

DOORS IN SIZES 100N AND 100E
AVAILABLE ONLY IN THE
INDICATED COLOURS

COLOURS AVAILABLE WHILE
STOCKS LAST

EXTERIOR FULL DOORS



EMBOSSING T46

	Ud
55 STANDARD	1,3
55 PREMIUM	1,2
55 PREMIUM PLUS	1,2
72 STANDARD	1,3
72 PREMIUM	1,2
72 PREMIUM PLUS	1,0
72 PREMIUM ALU	0,88
72 PREMIUM H PLUS	1,0
72 PREMIUM H ALU	0,88
85 STANDARD	1,2
85 PREMIUM	1,1
85 PREMIUM PLUS	0,91
85 PREMIUM ALU	0,85
85 PREMIUM H PLUS	0,91
85 PREMIUM H ALU	0,85
72 ECO THERM	0,88
101 MASTER THERM	0,63

AVAILABLE SIZES:
80N, 80E, 90N, 90E, 100N, 100E

SURCHARGE FOR WIDTH 100

**85MM THICK DOORS ARE MADE
IN COLOURS: WHITE, TURNER OAK, WINCHESTER,
GOLDEN OAK, DARKWALNUT, SWAMP OAK, DARKANTHRACITE,
WOOD-LIKE ANTHRACITE, RED, BLUE, GREEN, STRUCTURAL BLACK
IN SIZES 80N, 80E, 90N, 90E**

EXTERIOR FULL DOORS

STANDARD COLOURS

-  WHITE
-  WHITE WOOD-LIKE
-  LIGHT GREY
-  CONCRETE
-  BLEACHED OAK
-  SONOMA OAK
-  SHEFFIELD OAK
-  WINCHESTER
-  GOLDEN OAK
-  CORTEN
-  DARK WALNUT
-  RUSTIC OAK
-  HORIZONTAL
-  DARK MAHOGANY
-  SWAMP OAK
-  DARK ANTHRACITE
-  WOOD-LIKE ANTHRACITE
- NEW !**
-  RED
-  BLUE
-  GREEN
-  STRUCTURAL BLACK

EXCLUSIVE COLOURS

-  TURNER OAK
-  BLACKWOOD-LIKE

 DOORS IN SIZES 100N AND 100E AVAILABLE ONLY IN THE INDICATED COLOURS

 COLOURS AVAILABLE WHILE STOCKS LAST

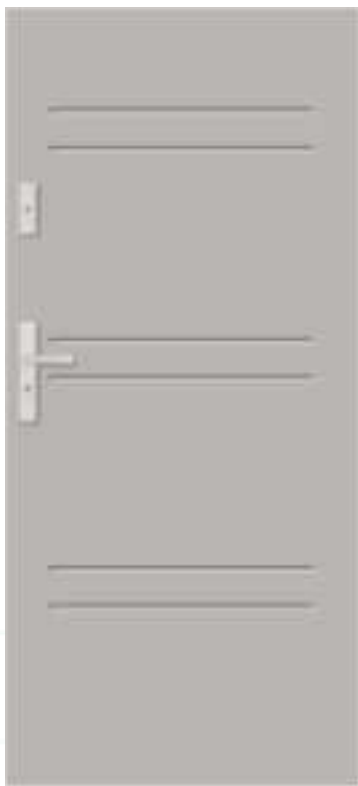

T47



T48



T49



T50

STANDARD COLOURS

WHITE	
WHITE WOOD-LIKE	
LIGHT GREY	
CONCRETE	
BLEACHED OAK	
SONOMA OAK	
SHEFFIELD OAK	
WINCHESTER	
GOLDEN OAK	
CORTEN	
DARK WALNUT	
RUSTIC OAK	
HORIZONTAL	
DARK MAHOGANY	
SWAMP OAK	
DARK ANTHRACITE	
WOOD-LIKE ANTHRACITE	
NEW !	
RED	
BLUE	
GREEN	
STRUCTURAL BLACK	

EXCLUSIVE COLOURS

TURNER OAK	
BLACKWOOD-LIKE	

DOORS IN SIZES 100N AND 100E
AVAILABLE ONLY IN THE
INDICATED COLOURS

COLOURS AVAILABLE WHILE
STOCKS LAST

EXTERIOR FULL DOORS



EMBOSSING T51

AVAILABLE SIZES:
80N, 80E, 90N, 90E, 100N, 100E

SURCHARGE FOR WIDTH 100

85MM THICK DOORS ARE MADE
IN COLOURS: WHITE, TURNER OAK, WINCHESTER,
GOLDEN OAK, DARKWALNUT, SWAMP OAK, DARKANTHRACITE,
WOOD-LIKE ANTHRACITE, RED, BLUE, GREEN, STRUCTURAL BLACK
IN SIZES 80N, 80E, 90N, 90E





	Ud
55 STANDARD	1,3
55 PREMIUM	1,2
55 PREMIUM PLUS	1,2
72 STANDARD	1,3
72 PREMIUM	1,2
72 PREMIUM PLUS	1,0
72 PREMIUM ALU	0,88
72 PREMIUM H PLUS	1,0
72 PREMIUM H ALU	0,88
85 STANDARD	1,2
85 PREMIUM	1,1
85 PREMIUM PLUS	0,91
85 PREMIUM ALU	0,85
85 PREMIUM H PLUS	0,91
85 PREMIUM H ALU	0,85
72 ECO THERM	0,88
101 MASTER THERM	0,63

EXTERIOR FULL DOORS

STANDARD COLOURS

-  WHITE
-  WHITE WOOD-LIKE
-  LIGHT GREY
-  CONCRETE
-  BLEACHED OAK
-  SONOMA OAK
-  SHEFFIELD OAK
-  WINCHESTER
-  GOLDEN OAK
-  CORTEN
-  DARK WALNUT
-  RUSTIC OAK
-  HORIZONTAL
-  DARK MAHOGANY
-  SWAMP OAK
-  DARK ANTHRACITE
-  WOOD-LIKE ANTHRACITE

NEW !

-  RED
-  BLUE
-  GREEN
-  STRUCTURAL BLACK

EXCLUSIVE COLOURS

-  TURNER OAK
-  BLACKWOOD-LIKE

 DOORS IN SIZES 100N AND 100E AVAILABLE ONLY IN THE INDICATED COLOURS

 COLOURS AVAILABLE WHILE STOCKS LAST



T52



T53



T54



T58

STANDARD COLOURS

WHITE	
WHITE WOOD-LIKE	
LIGHT GREY	
CONCRETE	
BLEACHED OAK	
SONOMA OAK	
SHEFFIELD OAK	
WINCHESTER	
GOLDEN OAK	
CORTEN	
DARK WALNUT	
RUSTIC OAK	
HORIZONTAL	
DARK MAHOGANY	
SWAMP OAK	
DARK ANTHRACITE	
WOOD-LIKE ANTHRACITE	
NEW !	
RED	
BLUE	
GREEN	
STRUCTURAL BLACK	

EXCLUSIVE COLOURS

TURNER OAK	
BLACKWOOD-LIKE	

DOORS IN SIZES 100N AND 100E
AVAILABLE ONLY IN THE
INDICATED COLOURS

COLOURS AVAILABLE WHILE
STOCKS LAST

EXTERIOR FULL DOORS



EMBOSSING T59

AVAILABLE SIZES:
80N, 80E, 90N, 90E, 100N, 100E

SURCHARGE FOR WIDTH 100

85MM THICK DOORS ARE MADE
IN COLOURS: WHITE, TURNER OAK, WINCHESTER,
GOLDEN OAK, DARK WALNUT, SWAMP OAK, DARK ANTHRACITE,
WOOD-LIKE ANTHRACITE, RED, BLUE, GREEN, STRUCTURAL BLACK
IN SIZES 80N, 80E, 90N, 90E

	Ud
55 STANDARD	1,3
55 PREMIUM	1,2
55 PREMIUM PLUS	1,2
72 STANDARD	1,3
72 PREMIUM	1,2
72 PREMIUM PLUS	1,0
72 PREMIUM ALU	0,88
72 PREMIUM H PLUS	1,0
72 PREMIUM H ALU	0,88
85 STANDARD	1,2
85 PREMIUM	1,1
85 PREMIUM PLUS	0,91
85 PREMIUM ALU	0,85
85 PREMIUM H PLUS	0,91
85 PREMIUM H ALU	0,85
72 ECO THERM	0,88
101 MASTER THERM	0,63

EXTERIOR FULL DOORS

STANDARD COLOURS

-  WHITE
-  WHITE WOOD-LIKE
-  LIGHT GREY
-  CONCRETE
-  BLEACHED OAK
-  SONOMA OAK
-  SHEFFIELD OAK
-  WINCHESTER
-  GOLDEN OAK
-  CORTEN
-  DARK WALNUT
-  RUSTIC OAK
-  HORIZONTAL
-  DARK MAHOGANY
-  SWAMP OAK
-  DARK ANTHRACITE
-  WOOD-LIKE ANTHRACITE
- NEW !**
-  RED
-  BLUE
-  GREEN
-  STRUCTURAL BLACK

EXCLUSIVE COLOURS

-  TURNER OAK
-  BLACKWOOD-LIKE

 DOORS IN SIZES 100N AND 100E AVAILABLE ONLY IN THE INDICATED COLOURS

 COLOURS AVAILABLE WHILE STOCKS LAST



T60



T61



T62



T63



EXTERIOR DOUBLE-LEAF DOORS



STANDARD COLOURS

- WHITE 
- WHITE WOOD-LIKE 
- LIGHT GREY 
- CONCRETE 
- BLEACHED OAK 
- SONOMA OAK 
- SHEFFIELD OAK 
- WINCHESTER 
- GOLDEN OAK 
- CORTEN 
- DARK WALNUT 
- RUSTIC OAK 
- HORIZONTAL 
- DARK MAHOGANY 
- SWAMP OAK 
- DARK ANTHRACITE 
- WOOD-LIKE ANTHRACITE 
- NEW !**
- RED 
- BLUE 
- GREEN 
- STRUCTURAL BLACK 

EXCLUSIVE COLOURS

- TURNER OAK 
- BLACKWOOD-LIKE 

DOORS IN SIZES 100N AND 100E
AVAILABLE ONLY IN THE
INDICATED COLOURS

COLOURS AVAILABLE WHILE
STOCKS LAST

EXTERIOR DOUBLE-LEAF DOORS | CONFIGURATION EXAMPLES



G

PASSIVE LEAVES

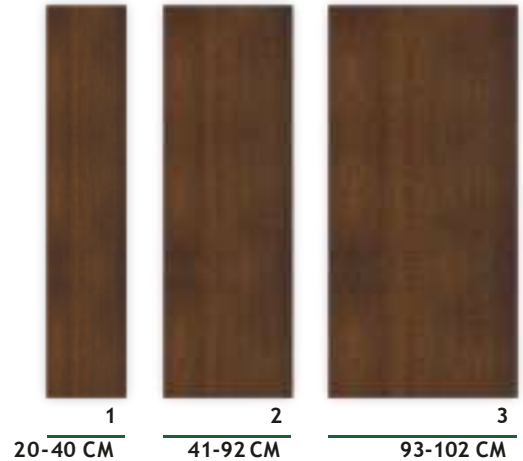

EMBOSSING AND GLAZING POSSIBLE IN PASSIVE LEAF WITH A MINIMUM WIDTH OF 350MM

METHOD FOR SET QUOTATION:

ACTIVE LEAF [PRICE ACC. TO THE PRICE LIST OF SINGLE-LEAFDOORS]

NOTE:

WHEN SELECTING DOUBLE-LEAFDOORS IN THE RC2CLASS, ADD A SURCHARGE TO THE PRICE OF THE ACTIVE LEAF

+PASSIVE LEAF

+ADDITIONALEQUIPMENT [RAPPERS, LIGHTS, GLAZING AND DECORS FOR PASSIVE LEAVES]

METHOD FOR CALCULATINGTHE WIDTH OF THE PASSIVE LEAF:

THE WIDTH OF THE PASSIVE LEAF IS CALCULATEDBY SUBTRACTING THE WIDTH OF THE MOUNTING HOLE OF THE ACTIVE DOOR FROM THE WIDTH OF THE OPENING IN THE WALL AND 9 MM FOR THE MASKING STRIP LOCATEDBETWEEN THE ACTIVE AND PASSIVE LEAVES.

EXAMPLE:

1400MMHOLE IN THE WALL

- (LESS) 1021MM |WITH OF THE MOUNTING HOLE OF 55MM THICK DOOR ON A FD-25/21/BSIZE90E FRAME

- (LESS) 9MM |MASKING STRIP

=370MM |WIDTH OF THE PASSIVE LEAF

NOTE:

MOUNTING CLEARANCE SUGGESTED BY LUX SECURITY DOORS IS 10MM PER SIDE

EXTERIOR DOUBLE-LEAF DOORS | CONFIGURATION EXAMPLES

STANDARD COLOURS

-  WHITE
-  WHITE WOOD-LIKE
-  LIGHT GREY
-  CONCRETE
-  BLEACHED OAK
-  SONOMA OAK
-  SHEFFIELD OAK
-  WINCHESTER
-  GOLDEN OAK
-  CORTEN
-  DARK WALNUT
-  RUSTIC OAK
-  HORIZONTAL
-  DARK MAHOGANY
-  SWAMP OAK
-  DARK ANTHRACITE
-  WOOD-LIKE ANTHRACITE
- NEW !**
-  RED
-  BLUE
-  GREEN
-  STRUCTURAL BLACK

EXCLUSIVE COLOURS

-  TURNER OAK
-  BLACKWOOD-LIKE

 DOORS IN SIZES 100N AND 100E AVAILABLE ONLY IN THE INDICATED COLOURS

 COLOURS AVAILABLE WHILE STOCKS LAST



T43

PASSIVE LEAVES

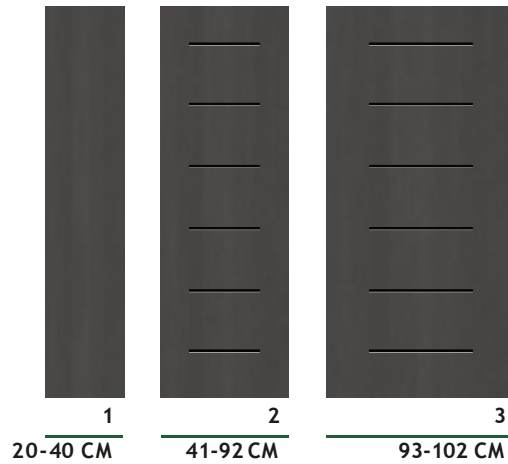

EMBOSSING AND GLAZING POSSIBLE IN PASSIVE LEAF WITH A MINIMUM WIDTH OF 350MM



G A21

PASSIVE LEAVES

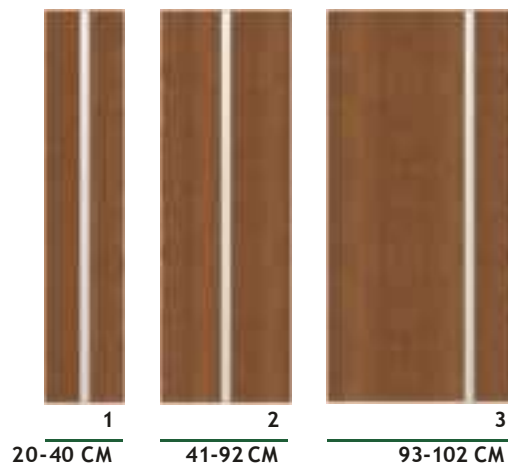

EMBOSSING AND GLAZING POSSIBLE IN PASSIVE LEAF WITH A MINIMUM WIDTH OF 350MM

STANDARD COLOURS

- WHITE 
- WHITE WOOD-LIKE 
- LIGHT GREY 
- CONCRETE 
- BLEACHED OAK 
- SONOMA OAK 
- SHEFFIELD OAK 
- WINCHESTER 
- GOLDEN OAK 
- CORTEN 
- DARK WALNUT 
- RUSTIC OAK 
- HORIZONTAL 
- DARK MAHOGANY 
- SWAMP OAK 
- DARK ANTHRACITE 
- WOOD-LIKE ANTHRACITE 
- NEW !**
- RED 
- BLUE 
- GREEN 
- STRUCTURAL BLACK 

EXCLUSIVE COLOURS

- TURNER OAK 
- BLACKWOOD-LIKE 

DOORS IN SIZES 100N AND 100E
AVAILABLE ONLY IN THE
INDICATED COLOURS

COLOURS AVAILABLE WHILE
STOCKS LAST

EXTERIOR DOUBLE-LEAF DOORS | CONFIGURATION EXAMPLES



T60 S33

PASSIVE LEAVES

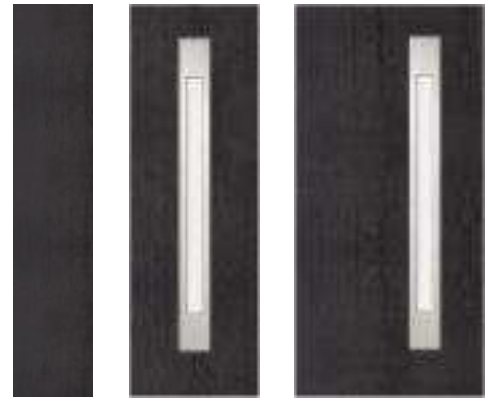

1 2 3
20-40 CM 41-92 CM 93-102 CM

EMBOSSING AND GLAZING POSSIBLE IN PASSIVE LEAF WITH A MINIMUM WIDTH OF 350MM



T41S61

PASSIVE LEAVES

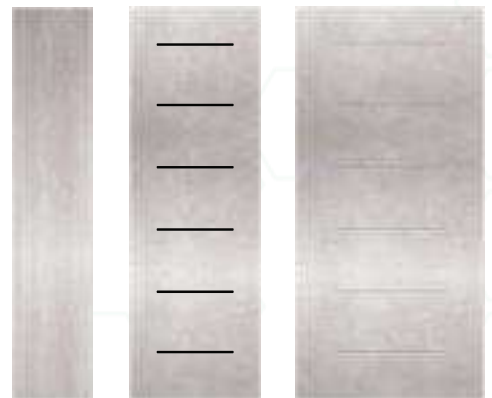

1 2 3
20-40 CM 41-92 CM 93-102 CM

EMBOSSING AND GLAZING POSSIBLE IN PASSIVE LEAF WITH A MINIMUM WIDTH OF 350MM

EXTERIOR DOORS WITH LIGHT



COLOURS AVAILABLE FOR
FRAMES AND PROFILES
OF ALUMINIUM
LIGHTS FOR
85 & 72MM THICK DOORS

TURNER OAK



WINCHESTER



GOLDEN OAK



DARK WALNUT



SWAMP OAK



DARK ANTHRACITE



WOOD-LIKE
ANTHRACITE



WHITE
RAL 9016



BLACK
RAL 9005



EXECUTION OPTIONS

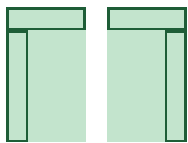
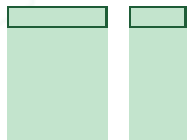
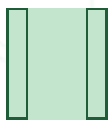
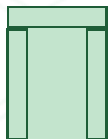

EXTERIOR DOORS WITH LIGHTS | PRICE LIST OF LIGHTS FOR 85MM THICK DOORS



T60 | RAPPER

METHOD FOR SET QUOTATION:
SINGLE OR DOUBLE-LEAF DOORS WITH
STEEL FRAME
+ ALUMINIUM FRAME SURCHARGE
+ LIGHTS ACCORDING TO THE PRICE LIST

EXTERIOR DOORS WITH LIGHTS | PRICE LIST OF LIGHTS FOR 72MM THICK DOORS



A11 | RAPPER

EXTERIOR DOORS WITH LIGHTS | PRICE LIST OF LIGHTS FOR 85MM THICK DOORS



G S33

COLOURS AVAILABLE FOR
FRAMES AND PROFILES
OF ALUMINIUM
LIGHTS FOR
85 & 72MM THICK DOORS

-  TURNER OAK
-  WINCHESTER
-  GOLDEN OAK
-  DARK WALNUT
-  SWAMP OAK
-  DARK ANTHRACITE
-  WOOD-LIKE ANTHRACITE
-  WHITE RAL 9016
-  BLACK RAL 9005

EXTERIOR DOORS WITH LIGHTS | PRICE LIST OF LIGHTS FOR 72MM THICK DOORS



T47

METHOD FOR SET QUOTATION:
SINGLE OR DOUBLE-LEAF DOORS WITH
STEEL FRAME
+ ALUMINIUM FRAME SURCHARGE
+ LIGHTS ACCORDING TO THE PRICE LIST

EXECUTION OPTIONS

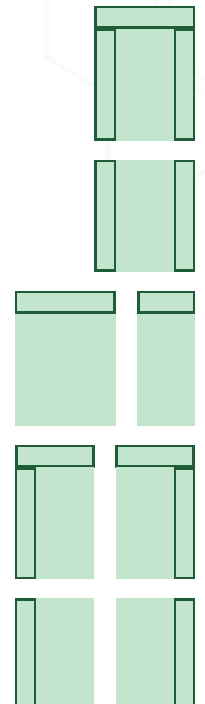



SECURITY DOORS



CONSTRUCTION

CONSTRUCTION OF DOORS



RC 3

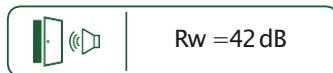

Rw =42 dB



DOORS MADE TOSIZE

SOUND INSULATION INDEX



EI 30



SMOKE TIGHTNESS
Sa, S200

SPARK 2 | FIRE - INTERNAL

55MMTHICK LEAF WITH THREE SIDED UP STAND, STRUCTURE BASED ON FULL WOODEN FRAME, MADE OF 0.6MM GALVANISED AND LAMINATED STEEL SHEET, FILLED WITH FIREPROOF AND SOUND-ABSORBING INSERT BASED ON MINERALWOOL, EQUIPPED WITH TWO GASKETS



THREE ANTI-BURGLARY PINS ON THE HINGED SIDE OF THE DOOR



3 Z5 TRIPLE HINGES, INCLUDING ONE SELF-CLOSING



THREE POINT LOCK CONSISTING OF A FIVE BOLT MAIN LOCK AND TWO THREE BOLT ADDITIONAL LOCKS



THREE-BARTOP LOCK



1.5MM GALVANISED SHEET STEEL FRAME, LAMINATED IN THE LEAF COLOUR, EQUIPPED WITH A GASKET



STEEL STILL WITH A GASKET

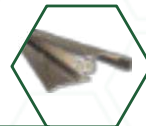

AXA ROYAL FLEX HANDLE



B-CLASS APPROVED ONE KEY INSERT AND KNOB-INSERT



AVAILABLE FRAME MODELS

STANDARD



FD-25/12



FD-25/21/B

FOR A SURCHARGE



FD-25/12+GRILLE



FD-25/12+PORTAL



SPARK 1 | FIRE - INTERNAL

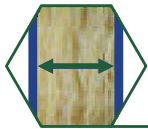

55MM THICK LEAF WITH THREE-SIDED UP STAND, STRUCTURE BASED ON FULL WOODEN FRAME, MADE OF 0.6MM GALVANISED AND LAMINATED STEEL SHEET, FILLED WITH FIREPROOF AND SOUND-ABSORBING INSERT BASED ON MINERAL WOOL, EQUIPPED WITH TWO GASKETS

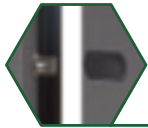

THREE ANTI-BURGLARY PINS ON THE HINGED SIDE OF THE DOOR

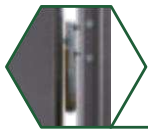

3 Z5 TRIPLE HINGES, INCLUDING ONE SELF-CLOSING

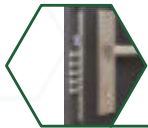

FIVE-BOLT MAIN LOCK

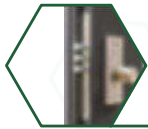

THREE-BAR TOP LOCK



STEEL FRAME MADE OF GALVANISED SHEET WITH A THICKNESS OF 1.5MM, LAMINATED IN THE COLOUR OF THE LEAF, EQUIPPED WITH GASKET

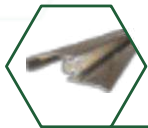

STEEL STILL WITH A GASKET



AXA ROYAL FLEX HANDLE



B-CLASS APPROVED ONE KEY INSERT AND KNOB-INSERT



AVAILABLE FRAME MODELS

STANDARD



FD-25/12



FD-25/21/B

FOR A SURCHARGE



FD-25/12+GRILLE



FD-25/12+PORTAL

CONSTRUCTION OF DOORS



AMADEO |ACOUSTIC

SOUND INSULATION INDEX



55MMTHICK LEAF WITH THREE SIDED UP STAND, STRUCTURE BASED ON FULL WOODEN FRAME, MADE OF 1.0MM GALVANISED AND LAMINATED STEEL SHEET, FILLED WITH SOUND-ABSORBING INSERT BASED ON MINERAL WOOL, EQUIPPED WITH A GASKET



THREE ANTI-BURGLARY PINS ON THE HINGED SIDE OF THE DOOR



THREE THREE-SECTION Z5 HINGES

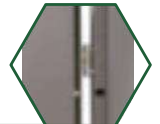

THREE-POINT LOCK CONSISTING OF A FIVE-BOLT MAIN LOCK, BOTTOM THREE BOLT LOCK AND VERTICAL BOLT



VERTICAL BOLT

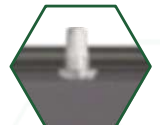

THREE-BAR TOP LOCK



STEEL FRAME MADE OF GALVANISED SHEET WITH A THICKNESS OF 1.5MM, LAMINATED IN THE COLOUR OF THE LEAF, EQUIPPED WITH A GASKET



STEEL STILL WITH A GASKET



STP-OW HANDLE



B-CLASS APPROVED ONE KEY INSERT AND KNOB-INSERT



AVAILABLE FRAME MODELS

STANDARD



FD-25/12



FD-25/21/B



FD-25/21/C

FOR A SURCHARGE



FD-25/12+GRILLE



FD-25/12+PORTAL

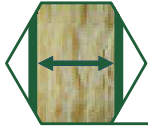
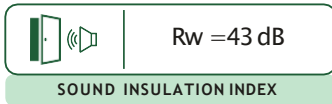

55MMTHICK LEAF WITH THREE-SIDEDUP STAND, THE STRUCTURE OF WHICH IS BASED ON A FULL WOODEN FRAME, MADE OF GALVANISED LAMINATED SHEET WITH A THICKNESS OF 0.6 MM FILLED WITH SOUND ABSORBING INSERT BASED ON MINERALWOOL, EQUIPPED WITH A GASKET

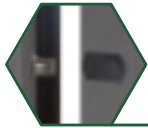

THREE ANTI-BURGLARYPINS ON THE HINGED SIDE OF THE DOOR

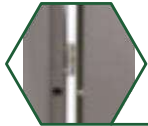

THREE THREE-SECTIONZ5 HINGES



THREE-POINT LOCK CONSISTING OF A FIVE-BOLTMAIN LOCK, BOTTOM THREE BOLT LOCK AND VERTICAL BOLT

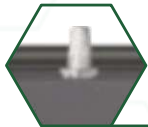

VERTICAL BOLT



THREE-BARTOP LOCK



STEEL FRAME MADE OF GALVANISEDSHEET WITH A THICKNESS OF 1.5MM, LAMINATEDIN THE COLOUR OF THE LEAF, EQUIPPED WITH A GASKET

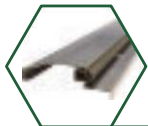

STEEL STILL WITH A GASKET



STP-OW HANDLE



B-CLASSAPPROVED ONE KEY INSERT AND KNOB-INSERT



AVAILABLEFRAME MODELS

STANDARD



FD-25/12



FD-25/21/B



FD-25/21/C

FOR A SURCHARGE



FD-25/12+GRILLE



FD-25/12+PORTAL

CONSTRUCTION OF DOORS



VERDI |ACOUSTIC

SOUND INSULATION INDEX

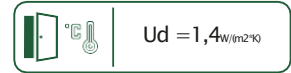

55MMTHICKLEAF WITH THREE SIDED UP STAND, STRUCTURE BASED ON FULL WOODEN FRAME, MADE OF 0.6MM GALVANISEDAND LAMINATED STEEL SHEET, FILLED WITH SOUND-ABSORBING INSERT BASED ON MINERAL WOOL, EQUIPPED WITH A GASKET



THREE ANTI-BURGLARYPINS ON THE HINGED SIDE OF THE DOOR



THREE THREE-SECTIONZ5 HINGES



BAR LOCK WITH ADJUSTABLE PRESSURE



THREE-BARMAIN LOCK



THREE-BARTOP LOCK



STEEL FRAME MADE OF GALVANISEDSHEET WITH A THICKNESS OF 1.2MM, LAMINATED IN THE COLOUR OF THE LEAF, EQUIPPED WITH A GASKET



STEEL STILL WITH A GASKET



STP-H/K2HANDLE



B-CLASSAPPROVED ONE KEY INSERT AND KNOB-INSERT



AVAILABLEFRAME MODELS

STANDARD



FD-25/12



FD-25/21/B



FD-25/21/C

FOR A SURCHARGE



FD-25/12+GRILLE



FD-25/12+PORTAL

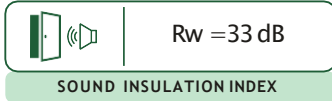

55MMTHICK LEAF WITH THREE-SIDEDUP STAND, MADE OF GALVANISED LAMINATED SHEET WITH A THICKNESS OF 1-1.2MM, FILLED WITH FOAMED POLYSTYRENE [STYROFOAM], EQUIPPED WITH A GASKET



SIX ANTI-BURGLARYBOLTSON THE HINGE SIDE OF THE DOOR



THREE THREE-SECTIONZ5 HINGES



THREE-POINT LOCK CONSISTING OF A FIVE-BOLTMAIN LOCK, BOTTOM THREE BOLT LOCK AND VERTICAL BOLT

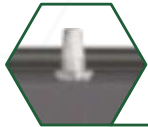

VERTICAL BOLT



THREE-BARTOP LOCK



STEEL FRAME MADE OF GALVANISED SHEET WITH A THICKNESS OF 1.5MM, LAMINATED IN THE COLOUR OF THE LEAF, EQUIPPED WITH GASKET

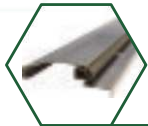

STEEL STILL WITH A GASKET



AXA TORONTO FLEX HANDLE



CLASS C ATTESTATION INSERT AND KNOB-INSERTIN ONE KEY SYSTEM



AVAILABLE FRAME MODELS

STANDARD



FD-25/12



FD-25/21/B



FD-25/21/C

FOR A SURCHARGE



FD-25/12+GRILLE



FD-25/12+PORTAL

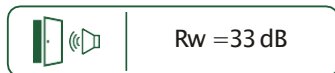

SOUND INSULATION INDEX

BATORY 47

47MM THICK LEAF WITH A THREE-SIDED UP STAND, MADE OF 1.2MM GALVANISED AND LAMINATED SHEET, FILLED WITH FOAMED POLYSTYRENE [STYROFOAM], EQUIPPED WITH A GASKET



SIX ANTI-BURGLARY BOLTSON THE HINGE SIDE OF THE DOOR



THREE THREE-SECTIONZ5 HINGES

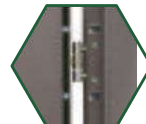

THREE-POINT LOCK CONSISTING OF A FIVE-BOLTMAIN LOCK, BOTTOM THREE BOLT LOCK AND VERTICAL BOLT



VERTICAL BOLT

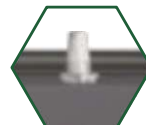

THREE-BARTOP LOCK



STEEL FRAME MADE OF GALVANISEDSHEET WITH A THICKNESS OF 1.5MM, LAMINATED IN LEAF COLOUR



STEEL STILL WITH A GASKET



AXA TORONTO FLEX HANDLE



CLASS C ATTESTATIONONE KEY INSERT AND KNOB-INSERT



AVAILABLE FRAME MODELS

STANDARD



FD-25/1/U



FD-25/16/U

FOR A SURCHARGE



FD-25/16/U+GRILLE



FD-25/16/U+PORTAL



55MMTHICK LEAF WITH THREE-SIDEDUP STAND, MADE OF 0.6MM THICKGALVANISED LAMINATED SHEET, FILLED WITH FOAMED POLYSTYRENE [STYROFOAM], EQUIPPED WITH A GASKET

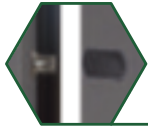

THREE ANTI-BURGLARYPINS ON THE HINGED SIDE OF THE DOOR

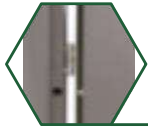

THREE THREE-SECTIONZ5 HINGES

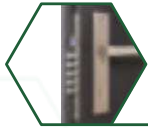

THREE-POINT LOCK CONSISTING OF A FIVE-BOLTMAIN LOCK, BOTTOM THREE BOLT LOCK AND VERTICAL BOLT

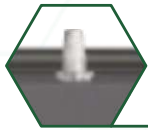

VERTICAL BOLT



THREE-BARTOP LOCK



STEEL FRAME MADE OF GALVANISEDSHEET WITH A THICKNESS OF 1.5MM, LAMINATEDIN THE COLOUR OF THE LEAF, EQUIPPED WITH GASKET

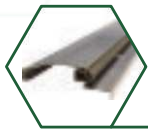

STEEL STILL WITH A GASKET



STP-OW HANDLE



CLASS B ATTESTATION INSERT AND KNOB-INSERTIN ONE KEY SYSTEM



AVAILABLE FRAME MODELS

STANDARD



FD-25/12



FD-25/21/B



FD-25/21/C

FOR A SURCHARGE



FD-25/12+GRILLE



FD-25/12+PORTAL



FD-25/21/P



SOUND INSULATION INDEX

HETMAN 47

47MM THICK LEAF WITH A THREE-SIDED UP STAND, MADE OF 0.6MM GALVANISED AND LAMINATED SHEET, FILLED WITH FOAMED POLYSTYRENE [STYROFOAM], EQUIPPED WITH A GASKET



THREE ANTI-BURGLARY PINS ON THE HINGED SIDE OF THE DOOR

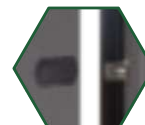

THREE THREE-SECTION Z5 HINGES

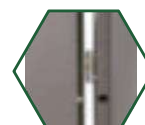

THREE-POINT LOCK CONSISTING OF A FIVE-BOLT MAIN LOCK, BOTTOM THREE BOLT LOCK AND VERTICAL BOLT



VERTICAL BOLT

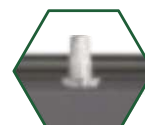

THREE-BAR TOP LOCK



STEEL FRAME MADE OF GALVANISED SHEET WITH A THICKNESS OF 1.5MM, LAMINATED IN LEAF COLOUR



STEEL STILL WITH A GASKET

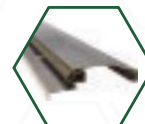

STP-OW HANDLE



B-CLASS APPROVED ONE KEY INSERT AND KNOB-INSERT



AVAILABLE FRAME MODELS

STANDARD



FD-25/1/U



FD-25/16/U

FOR A SURCHARGE



FD-25/16/U+GRILLE



FD-25/16/U+PORTAL

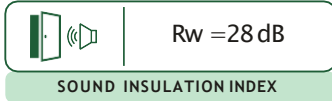

55MMTHICK LEAF WITH THREE-SIDEDUP STAND, MADE OF 0.6MM THICKGALVANISED LAMINATED SHEET, FILLED WITH FOAMED POLYSTYRENE [STYROFOAM], EQUIPPED WITH A GASKET



THREE ANTI-BURGLARYPINS ON THE HINGED SIDE OF THE DOOR



THREE THREE-SECTIONZ5 HINGES



THREE-BARMAIN LOCK



BAR LOCK WITH ADJUSTABLE PRESSURE



THREE-BARTOP LOCK



STEEL FRAME MADE OF GALVANISEDSHEET WITH A THICKNESS OF 1.2MM, LAMINATEDIN THE COLOUR OF THE LEAF, EQUIPPED WITH GASKET

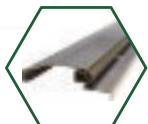

STEEL STILL WITH A GASKET



STP-H/K2HANDLE



CLASS B ATTESTATION INSERT AND KNOB-INSERTIN ONE KEY SYSTEM



AVAILABLEFRAME MODELS

STANDARD



FD-25/12



FD-25/21/B



FD-25/21/C

FOR A SURCHARGE



STEEL-WOODEN WITH 3D HINGE















FD-25/12+GRILLE



FD-25/12+PORTAL

INTRUSION RESISTANCE CLASSES

	TOOLS USED DURING BURGLARY	MINIMUM RESISTANCE TIME
DOOR CLASS	 RC 1 Without the use of tools: - attempt to force with shoulder or kicks, - attempt to lift or pull out the lock	  NO TESTS
	 RC 2 Attempted burglary using simple tools, e.g.: - screwdriver, pliers, wedge	  3 MINUTES
	 RC 3 Attempted burglary using other tools, e.g.: - crowbar, hammer, additional screwdriver, punch and mechanical drilling machine	  5 MINUTES
	 RC 4 Attempted burglary using tools as above and: - sledgehammer, saw, chisel, chisel, axe as well as simple power tools	  10 MINUTES

FIRE RESISTANCE CLASS

 EI 30 EI30 - fire door marking indicating that a given product provides protection against fire and high temperature for 36 minutes
--

SMOKE-TIGHTNESS CLASS

 SMOKE TIGHTNESS Sa, S200 Sa S200 - doors marked with this symbol are equipped with special sealing systems to protect against the spread of smoke in the event of a fire, and thus against poisoning by harmful combustion products
--



SECURITY DOORS

WITH EMBOSSING

STANDARD COLOURS

WHITE 

WHITE WOOD-LIKE 

LIGHT GREY 

CONCRETE 

BLEACHED OAK 

SONOMA OAK 

SHEFFIELD OAK 

WINCHESTER 

GOLDEN OAK 

DARK WALNUT 

RUSTIC OAK 

DARK MAHOGANY 

SWAMP OAK 

DARK ANTHRACITE 

WOOD-LIKE ANTHRACITE 

NEW !

RED 

BLUE 

GREEN 

STRUCTURAL BLACK 

EXCLUSIVE COLOURS

TURNER OAK 

DOORS IN SIZES 100N AND 100E
AVAILABLE ONLY IN THE
INDICATED COLOURS

COLOURS AVAILABLE WHILE
STOCKS LAST

SECURITYDOORS WITH EMBOSSING



SMOOTH | G

	RC	Rw	EI	Ud
SENATOR E	2	28	X	1,3
HETMAN 47	3	29	X	X
HETMAN 55	3	29	X	1,3
BATORY 47	4	33	X	X
BATORY 55	4	33	X	1,4
VERDI	2	42	X	1,4
MOZART	3	43	X	1,6
AMADEO	3	47	X	1,6
SPARK I	2	37	30	X
SPARK II	3	42	30	X

AVAILABLE SIZES:
80N, 80E, 90N, 90E, 100N, 100E

SURCHARGE FOR WIDTH 100

SECURITYDOORS WITH EMBOSSING

STANDARD COLOURS



T01



T02



T32



T34

-  WHITE
-  WHITE WOOD-LIKE
-  LIGHT GREY
-  CONCRETE
-  BLEACHED OAK
-  SONOMA OAK
-  SHEFFIELD OAK
-  WINCHESTER
-  GOLDEN OAK
-  DARK WALNUT
-  RUSTIC OAK
-  DARK MAHOGANY
-  SWAMP OAK
-  DARK ANTHRACITE
-  WOOD-LIKE ANTHRACITE
- NEW !**
-  RED
-  BLUE
-  GREEN
-  STRUCTURAL BLACK

EXCLUSIVE COLOURS

-  TURNER OAK

 DOORS IN SIZES 100N AND 100E AVAILABLE ONLY IN THE INDICATED COLOURS

 COLOURS AVAILABLE WHILE STOCKS LAST

STANDARD COLOURS

WHITE 

WHITE WOOD-LIKE 

LIGHT GREY 

CONCRETE 

BLEACHED OAK 

SONOMA OAK 

SHEFFIELD OAK 

WINCHESTER 

GOLDEN OAK 

DARK WALNUT 

RUSTIC OAK 

DARK MAHOGANY 

SWAMP OAK 

DARK ANTHRACITE 

WOOD-LIKE ANTHRACITE 

NEW !

RED 

BLUE 

GREEN 

STRUCTURAL BLACK 

EXCLUSIVE COLOURS

TURNER OAK 

DOORS IN SIZES 100N AND 100E
AVAILABLE ONLY IN THE
INDICATED COLOURS

COLOURS AVAILABLE WHILE
STOCKS LAST

SECURITYDOORS WITH EMBOSSING



EMBOSSING T41

	RC	Rw	EI	Ud
SENATOR E	2	28	X	1,3
HETMAN 47	3	29	X	X
HETMAN 55	3	29	X	1,3
BATORY 47	X	X	X	X
BATORY 55	X	X	X	X
VERDI	2	42	X	1,4
MOZART	3	43	X	1,6
AMADEO	X	X	X	X
SPARK I	2	37	30	X
SPARK II	3	42	30	X

AVAILABLE SIZES:
80N, 80E, 90N, 90E, 100N, 100E

SURCHARGE FOR WIDTH 100

SECURITYDOORS WITH EMBOSSING

STANDARD COLOURS

-  WHITE
-  WHITE WOOD-LIKE
-  LIGHT GREY
-  CONCRETE
-  BLEACHED OAK
-  SONOMA OAK
-  SHEFFIELD OAK
-  WINCHESTER
-  GOLDEN OAK
-  DARK WALNUT
-  RUSTIC OAK
-  DARK MAHOGANY
-  SWAMP OAK
-  DARK ANTHRACITE
-  WOOD-LIKE ANTHRACITE
- NEW !**
-  RED
-  BLUE
-  GREEN
-  STRUCTURAL BLACK

EXCLUSIVE COLOURS

-  TURNER OAK

 DOORS IN SIZES 100N AND 100E AVAILABLE ONLY IN THE INDICATED COLOURS

 COLOURS AVAILABLE WHILE STOCKS LAST



T42



T43



T44



T45

STANDARD COLOURS

WHITE 

WHITE WOOD-LIKE 

LIGHT GREY 

CONCRETE 

BLEACHED OAK 

SONOMA OAK 

SHEFFIELD OAK 

WINCHESTER 

GOLDEN OAK 

DARK WALNUT 

RUSTIC OAK 

DARK MAHOGANY 

SWAMP OAK 

DARK ANTHRACITE 

WOOD-LIKE ANTHRACITE 

NEW !

RED 

BLUE 

GREEN 

STRUCTURAL BLACK 

EXCLUSIVE COLOURS

TURNER OAK 

DOORS IN SIZES 100N AND 100E
AVAILABLE ONLY IN THE
INDICATED COLOURS

COLOURS AVAILABLE WHILE
STOCKS LAST

SECURITYDOORS WITH EMBOSSING



EMBOSSING T46

	RC	Rw	EI	Ud
SENATOR E	2	28	X	1,3
HETMAN 47	3	29	X	X
HETMAN 55	3	29	X	1,3
BATORY 47	X	X	X	X
BATORY 55	X	X	X	X
VERDI	2	42	X	1,4
MOZART	3	43	X	1,6
AMADEO	X	X	X	X
SPARK I	2	37	30	X
SPARK II	3	42	30	X

AVAILABLE SIZES:
80N, 80E, 90N, 90E, 100N, 100E

SURCHARGE FOR WIDTH 100

SECURITYDOORS WITH EMBOSSING

STANDARD COLOURS

-  WHITE
-  WHITE WOOD-LIKE
-  LIGHTGREY
-  CONCRETE
-  BLEACHED OAK
-  SONOMA OAK
-  SHEFFIELD OAK
-  WINCHESTER
-  GOLDEN OAK
-  DARK WALNUT
-  RUSTIC OAK
-  DARK MAHOGANY
-  SWAMP OAK
-  DARK ANTHRACITE
-  WOOD-LIKE ANTHRACITE
- NEW !**
-  RED
-  BLUE
-  GREEN
-  STRUCTURAL BLACK

EXCLUSIVE COLOURS

-  TURNER OAK

 DOORS IN SIZES 100N AND 100E AVAILABLE ONLY IN THE INDICATED COLOURS

 COLOURS AVAILABLE WHILE STOCKS LAST



T47



T48



T49



T50

STANDARD COLOURS

WHITE 

WHITE WOOD-LIKE 

LIGHT GREY 

CONCRETE 

BLEACHED OAK 

SONOMA OAK 

SHEFFIELD OAK 

WINCHESTER 

GOLDEN OAK 

DARK WALNUT 

RUSTIC OAK 

DARK MAHOGANY 

SWAMP OAK 

DARK ANTHRACITE 

WOOD-LIKE ANTHRACITE 

NEW !

RED 

BLUE 

GREEN 

STRUCTURAL BLACK 

EXCLUSIVE COLOURS

TURNER OAK 

DOORS IN SIZES 100N AND 100E
AVAILABLE ONLY IN THE
INDICATED COLOURS

COLOURS AVAILABLE WHILE
STOCKS LAST

SECURITYDOORS WITH EMBOSSING



EMBOSSING T51

	RC	Rw	EI	Ud
SENATOR E	2	28	X	1,3
HETMAN 47	3	29	X	X
HETMAN 55	3	29	X	1,3
BATORY 47	X	X	X	X
BATORY 55	X	X	X	X
VERDI	2	42	X	1,4
MOZART	3	43	X	1,6
AMADEO	X	X	X	X
SPARK I	2	37	30	X
SPARK II	3	42	30	X

AVAILABLE SIZES:
80N, 80E, 90N, 90E, 100N, 100E

SURCHARGE FOR WIDTH 100

SECURITYDOORS WITH EMBOSSING

STANDARD COLOURS



T52



T53



T54



T58

-  WHITE
-  WHITE WOOD-LIKE
-  LIGHT GREY
-  CONCRETE
-  BLEACHED OAK
-  SONOMA OAK
-  SHEFFIELD OAK
-  WINCHESTER
-  GOLDEN OAK
-  DARK WALNUT
-  RUSTIC OAK
-  DARK MAHOGANY
-  SWAMP OAK
-  DARK ANTHRACITE
-  WOOD-LIKE ANTHRACITE
- NEW !**
-  RED
-  BLUE
-  GREEN
-  STRUCTURAL BLACK

EXCLUSIVE COLOURS

-  TURNER OAK

 DOORS IN SIZES 100N AND 100E AVAILABLE ONLY IN THE INDICATED COLOURS

 COLOURS AVAILABLE WHILE STOCKS LAST

STANDARD COLOURS

WHITE 

WHITE WOOD-LIKE 

LIGHT GREY 

CONCRETE 

BLEACHED OAK 

SONOMA OAK 

SHEFFIELD OAK 

WINCHESTER 

GOLDEN OAK 

DARK WALNUT 

RUSTIC OAK 

DARK MAHOGANY 

SWAMP OAK 

DARK ANTHRACITE 

WOOD-LIKE ANTHRACITE 

NEW !

RED 

BLUE 

GREEN 

STRUCTURAL BLACK 

EXCLUSIVE COLOURS

TURNER OAK 

DOORS IN SIZES 100N AND 100E
AVAILABLE ONLY IN THE
INDICATED COLOURS

COLOURS AVAILABLE WHILE
STOCKS LAST

SECURITYDOORS WITH EMBOSSING



EMBOSSING T59

	RC	Rw	EI	Ud
SENATOR E	2	28	X	1,3
HETMAN 47	3	29	X	X
HETMAN 55	3	29	X	1,3
BATORY 47	X	X	X	X
BATORY 55	X	X	X	X
VERDI	2	42	X	1,4
MOZART	3	43	X	1,6
AMADEO	X	X	X	X
SPARK I	2	37	30	X
SPARK II	3	42	30	X

AVAILABLE SIZES:
80N, 80E, 90N, 90E, 100N, 100E

SURCHARGE FOR WIDTH 100

SECURITYDOORS WITH EMBOSSING

STANDARD COLOURS

-  WHITE
-  WHITE WOOD-LIKE
-  LIGHT GREY
-  CONCRETE
-  BLEACHED OAK
-  SONOMA OAK
-  SHEFFIELD OAK
-  WINCHESTER
-  GOLDEN OAK
-  DARK WALNUT
-  RUSTIC OAK
-  DARK MAHOGANY
-  SWAMP OAK
-  DARK ANTHRACITE
-  WOOD-LIKE ANTHRACITE
- NEW !**
-  RED
-  BLUE
-  GREEN
-  STRUCTURAL BLACK

EXCLUSIVE COLOURS

-  TURNER OAK

 DOORS IN SIZES 100N AND 100E AVAILABLE ONLY IN THE INDICATED COLOURS

 COLOURS AVAILABLE WHILE STOCKS LAST



T60



T61



T62



T63





SECURITY DOORS

WITH DECORS

STANDARD COLOURS

WHITE 

WHITE WOOD-LIKE 

LIGHT GREY 

CONCRETE 

BLEACHED OAK 

SONOMA OAK 

SHEFFIELD OAK 

WINCHESTER 

GOLDEN OAK 

DARK WALNUT 

RUSTIC OAK 

DARK MAHOGANY 

SWAMP OAK 

DARK ANTHRACITE 

WOOD-LIKE ANTHRACITE 

NEW !

RED 

BLUE 

GREEN 

STRUCTURAL BLACK 

EXCLUSIVE COLOURS

TURNER OAK 

DOORS IN SIZES 100N AND 100E
AVAILABLE ONLY IN THE
INDICATED COLOURS

COLOURS AVAILABLE WHILE
STOCKS LAST

SECURITY DOORS WITH DECORS



DECOR A8

DECOR WIDTH:
NARROW DECOR - 14MM
WIDE DECOR - 30MM

	RC	Rw	EI	Ud
SENATOR E	2	28	X	1,3
HETMAN 47	3	29	X	X
HETMAN 55	3	29	X	1,3
BATORY 47	4	33	X	X
BATORY 55	4	33	X	1,4
VERDI	2	42	X	1,4
MOZART	3	43	X	1,6
AMADEO	3	47	X	1,6
SPARK I	2	37	30	X
SPARK II	3	42	30	X

AVAILABLE SIZES:

80N, 80E, 90N, 90E, 100N, 100E

SURCHARGE FOR WIDTH 100

PRICES ARE GIVEN FOR THE VERSION WITH ONE-SIDED DECOR.

WHEN ORDERING A TWO-SIDED VERSION, A SURCHARGE OF PLN 200.00 APPLIES

OTHER DECORS MODELS CAN BE FOUND ON PAGE 151 OF THE CATALOGUE

SECURITY DOORS WITH DECORS

STANDARD COLOURS

-  WHITE
-  WHITE WOOD-LIKE
-  LIGHT GREY
-  CONCRETE
-  BLEACHED OAK
-  SONOMA OAK
-  SHEFFIELD OAK
-  WINCHESTER
-  GOLDEN OAK
-  DARK WALNUT
-  RUSTIC OAK
-  DARK MAHOGANY
-  SWAMP OAK
-  DARK ANTHRACITE
-  WOOD-LIKE ANTHRACITE
- NEW !**
-  RED
-  BLUE
-  GREEN
-  STRUCTURAL BLACK

EXCLUSIVE COLOURS

-  TURNER OAK

 DOORS IN SIZES 100N AND 100E AVAILABLE ONLY IN THE INDICATED COLOURS

 COLOURS AVAILABLE WHILE STOCKS LAST



A7



A10



A11



A21



TECHNICAL DOORS



CONSTRUCTION

TECHNICAL



40 MM THICK LEAF WITH A THREE-SIDED UP STAND, MADE OF 0.5MM GALVANISED AND PAINTED SHEET, FILLED WITH FOAMED POLYSTYRENE [STYROFOAM]



Z2 PLATE HINGE



BOTTOM LOCK

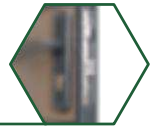

STEEL FRAME WITH FD-25/21/N/O PROFILE MADE OF SHEET METAL WITH A THICKNESS OF 1-1.2MM, PAINTED IN THE COLOUR OF THE LEAF

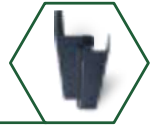

SAFETY HANDLE

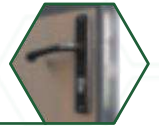

KEY-KEYINSERT



EXECUTION OPTIONS SUBJECT TO SURCHARGE

FRAMES



FD-21/N



FD-21/C



FD-21/B



FD-22

SILLS



STEEL 21/N/SILL



STILL 21/B/C

VENTILATION GRILLES



PVC VENTILATION GRILLE - WHITE



PVC VENTILATION GRILLE - ASH GREY



PVC VENTILATION GRILLE - BROWN



PVC VENTILATION GRILLE - BLACK



VENTILATION GRILLE INOX

VENTILATION SLEEVES



VENTILATION SLEEVE WHITE



ASH GREY VENTILATION SLEEVE



BRONZE VENTILATION SLEEVE



VENTILATION SLEEVE BLACK

AVAILABLE COLOURS



RAL9010
WHITE



RAL7035
ASH GREY



RAL8017
BRONZE



RAL7016
ANTHRACITE

TECHNICAL DOOR | FULL

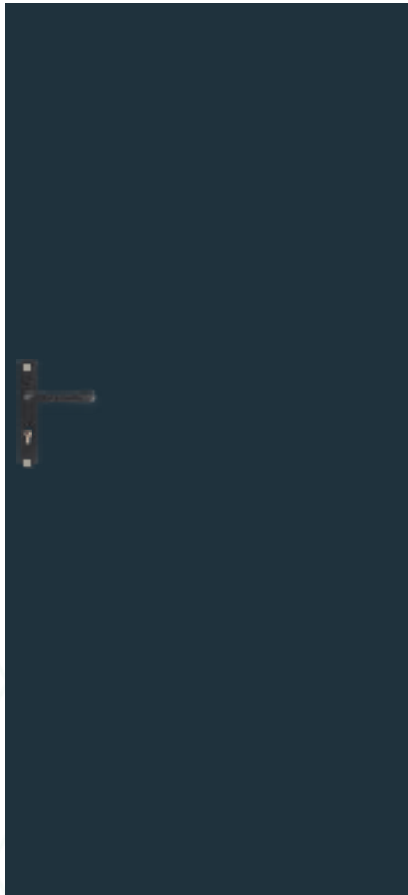

RAL 7016
G

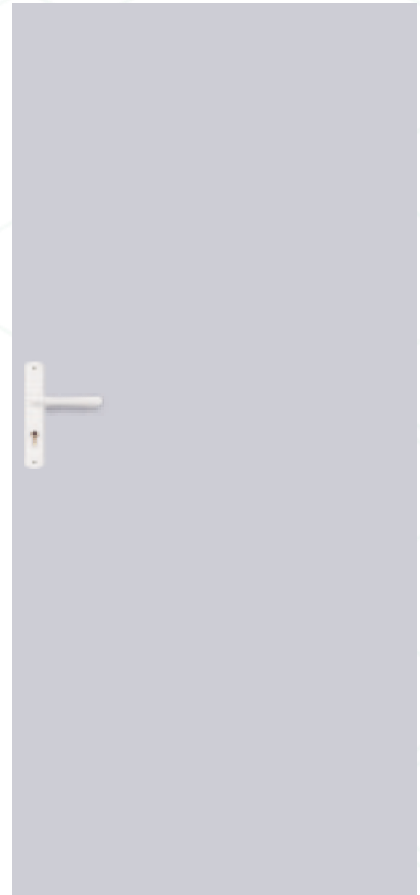

RAL 7035
G

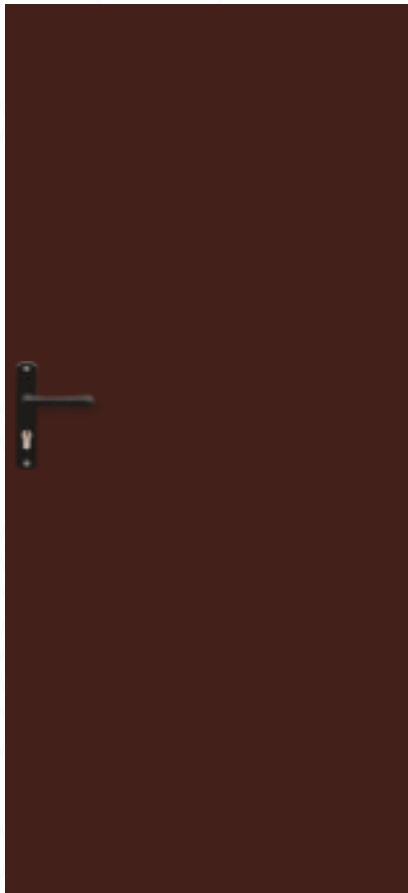

RAL 8017
G



RAL 9010
G

TECHNICAL DOORS | GLAZED

AVAILABLE COLOURS



RAL9010
WHITE



RAL7035
ASH GREY



RAL8017
BRONZE



RAL7016
ANTHRACITE

RAL 7035
G /ST 1



RAL 7016
G /ST 2



RAL 8017
G /ST 3



		FULL FD-25/21/N/OFRAME
OPTIONAL FINISH		FULL FD-25/NFRAME
		FULL FD-25/CFRAME
		FULL FD-25/BFRAME
		STEEL SILL SURCHARGE
	WITH FD-25/21/N/OFRAME	ST1GLAZED TRANSPARENT
		ST2 GLAZED TRANSPARENT
		ST3 GLAZED TRANSPARENT
		ST1GLAZED FROSTED
		ST2 GLAZED FROSTED
		ST3 GLAZED FROSTED
		WITH PVC VENTILATION GRILLE OR SLEEVE
		WITH AN INOX VENTILATION GRILLE
		WITH WC LOCK(WITH OLARIXWC HANDLE)
		WITH TOP LOCK

AVAILABLE SIZES: 60, 70, 80, 80E, 90, 90E, 100, 100E

SURCHARGES: 60, 70, 80E, 90E, 100, 100E

AVAILABLE COLOURS



RAL9010
WHITE



RAL7035
ASH GREY



RAL8017
BRONZE



RAL7016
ANTHRACITE

TECHNICAL DOORS | WITH PANELS

RAL 8017

G
CENTRE PANEL AND
BOTTOM PANEL WITH BUILT-IN
VENTILATION GRILLE



RAL 7016

G
CENTRE PANEL AND
BOTTOM PANEL



RAL 9010

G
BOTTOM PANEL



	FULL DOOR LEAF WITHOUT FRAME
	FULL FD-25/21/N/OFRAME
OPTIONAL VERSION	BOTTOM PANEL WITH VENTILATION GRILLE INOX/BLACK - DOUBLE SIDED
	INOX/BLACK BOTTOM PANEL SINGLE SIDE
	INOX/BLACK BOTTOM PANEL DOUBLE SIDED
	INOX/BLACK CENTRE PANEL ONE-SIDED
	INOX/BLACK CENTRE PANEL DOUBLE-SIDED
	INOX BOTTOMPANEL +INOX CENTRE PANEL - ONE-SIDED
	INOX BOTTOMPANEL +INOX CENTRE PANEL - DOUBLE-SIDED
	BOTTOM PANEL WITH VENTILATIONGRILLE FUNCTION +INOX CENTRE PANEL - DOUBLE-SIDED

AVAILABLE SIZES: 60, 70, 80, 80E, 90, 90E, 100, 100E

SURCHARGES: 60, 70, 80E, 90E, 100, 100E



SECTIONAL GARAGE DOORS





Sectional garage doors are used in construction of detached and multi-family buildings. The individual preferences of our customers are reflected by our personalised products manufactured on order. Selected colours of high-quality door panels and a wide selection of laminates of external doors allow you to create well composed colour sets that will become a showcase of the house.

For convenience of use, garage doors can be equipped with an automatic drive. Our offer includes automation for the doors of the leading manufacturers: Somfy and Beninca.



DOORS | SAFETY OF USE AS STANDARD

- A safety mechanism to prevent the door from falling down in the event of a spring breakage
- Panels with a safety lock to protect against accidental pinching of fingers
- Profiled roll safety guides to prevent rolls from falling out
- Omega trapezoid reinforcements prevent panels longer than 5m from bending
- Amperometric obstacle detection system – used to detect possible obstacles that may occur on the track of the door. Thanks to this function, when an obstacle is encountered, the drive stops the door and changes the direction of its movement

STANDARD EQUIPMENT

- Door made of 40 mm thick panels filled with polyurethane foam finished with galvanised steel sheet
- Support frame – angles and guides made of galvanised steel profiles with a thickness of 2 mm
- Front torsion springs with standard number of cycles equal to 15000
- Central and side hinges made of galvanised steel sheet

The lock, handle, grip, drive and bolt are added to the order at the Customer's request.

THERMAL CONDUCTIVITY

Panels used in the production of our doors are characterised by thermal insulation parameter at the level of $U_d = 0.74 \text{ W}/(\text{m}^2 \cdot \text{K})$.



AVAILABLE COLORS FOR THE SLICK STRUCTURE



WINCHESTER



GOLDEN OAK

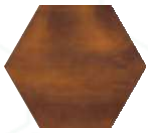

DARK WALNUT



SWAMP OAK



DARK ANTHRACITE



WOOD-LIKE ANTHRACITE

AVAILABLE COLOURS IN THE WOODGRAIN STRUCTURE



WHITE



BROWN

DOORS | SECTIONAL GARAGE

PANEL WITHOUT EMBOSSING



WINCHESTER COLOUR DOOR | SLICK



PANEL WITHOUT EMBOSSING

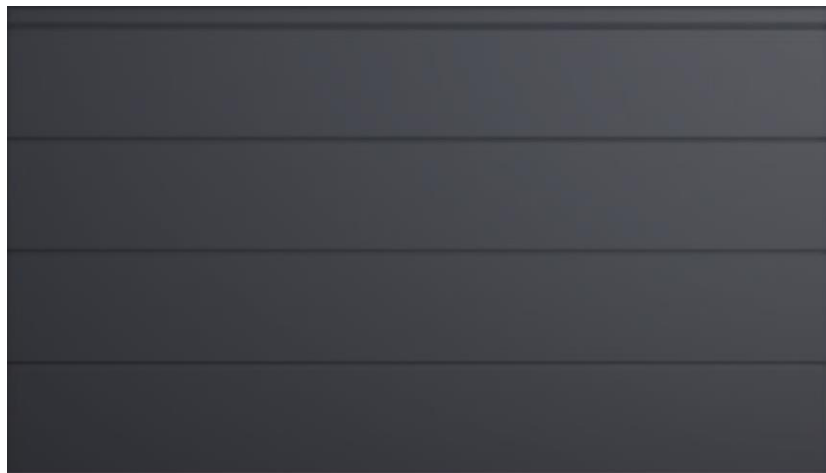

DARK ANTHRACITE DOOR | SLICK



ADDITIONAL EXECUTION OPTIONS

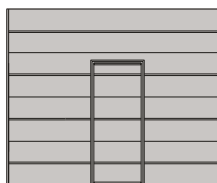

DOOR WITH PASS-THROUGH DOOR AND LOW THRESHOLD

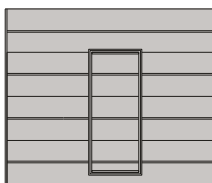

DOORS WITH PASS-THROUGH DOOR AND HIGH THRESHOLD

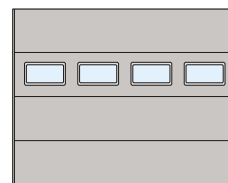

WINDOW PANEL

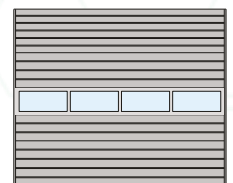

ALUMINIUM SECTION PANEL

DOORS | SECTIONAL GARAGE

NARROW EMBOSSING PANEL



DOOR IN WHITE | WOODGRAIN

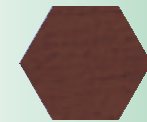

BROWN | WOODGRAIN



WHITE | WOODGRAIN

AVAILABLE
COLOURS

WIDE EMBOSSED PANEL



GOLDEN OAK DOOR | SLICK

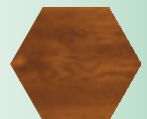

GOLD OAK



DARK WALNUT

AVAILABLE
COLOURS

ADDITIONAL EXECUTION OPTIONS

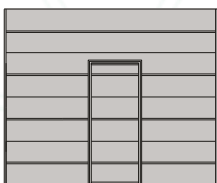

DOOR WITH PASS-
THROUGH DOOR AND
LOW THRESHOLD

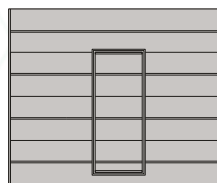

DOORS WITH PASS-
THROUGH DOOR AND
HIGH THRESHOLD

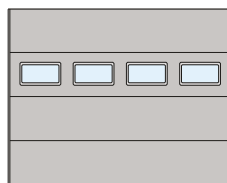

WINDOW PANEL

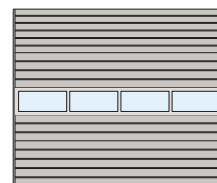

ALUMINIUM SECTION
PANEL

AVAILABLE COLOURS FOR THE SLICK STRUCTURE



WINCHESTER

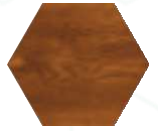

GOLDEN OAK

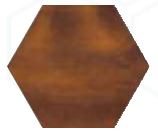

DARK WALNUT



SWAMP OAK



DARK ANTHRACITE



WOOD-LIKE
ANTHRACITE

AVAILABLE COLOURS IN THE WOODGRAIN STRUCTURE



WHITE



BROWN

DOORS | SOMFY DOOR AUTOMATION

Somfy –the world leader among manufacturers of door automation. All Somfy products are tested under the most demanding conditions, which translates into their durability and reliability. Somfy drives are equipped with a chain drive as standard, which can be replaced with a kevlar belt at the customer's request placed when ordering.

SOMFY DEXXO OPTIMO

Perfect for sectional doors with a maximum surface area of up to 10m².

SOMFY DEXXO OPTIMO RTS	
124V MOTOR WITH BUILT-IN CONTROLLER AND RTS RECEIVER	
800 N DRIVE GUIDE WITH CHAIN	2.9 M TESTED FOR 36500 CYCLES
	3.5M TESTED FOR 36500 CYCLES
1 SOMFY KEYTIS 22-CHANNEL REMOTE CONTROL	

SOMFY DEXXO PRO

Suitable for doors with a surface area of up to 15m².

SOMFY DEXXO PRO	
124V MOTOR WITH BUILT-IN CONTROLLER AND RTS RECEIVER	
1000 N DRIVE GUIDE WITH CHAIN	2.9 M TESTED FOR 36500 CYCLES
	3.5M TESTED FOR 36500 CYCLES
2 SOMFY KEYGO RTS 4-CHANNEL REMOTES	



Are you just starting your adventure with new technologies and you do not know what home devices you will want to operate using the application yet? Select TaHoma and the Smart IO drive – it will allow you to control the doors from your phone, and nothing stands in the way of managing central heating, roller shutters or lighting therewith.



DOORS | BENINCA DOOR AUTOMATION

JIMs are PREMIUM products and the best value for money. They have a kevlar belt drive, thanks to which the actuators work quietly and smoothly. The kevlar belt is reinforced with three or four (depending on the model) steel ropes. Two basic JIM actuator models are manufactured: JIM.3 and JIM.4.

BENINCA JIM.3

Suitable for doors with a surface area of up to 11m².

BENINCA JIM.3	
124V MOTOR WITH BUILT-IN ENCODER AND RECEIVER	
600 N DRIVE GUIDE WITH PTC BELT	PTCL.3 FOR DOORS UP TO 2.5M HIGH
	PTCL.4 FOR DOORS UP TO 3.5M HIGH
1 TO.G02VA 2-CHANNEL REMOTE CONTROL	

BENINCA JIM.4

Perfect for sectional doors with a maximum surface area of up to 22m².

BENINCA JIM.4	
124V MOTOR WITH BUILT-IN ENCODER AND RECEIVER	
1200 N DRIVE GUIDE WITH BELT	PTCL.3 FOR DOORS UP TO 2.5M HIGH
	PTCL.4 FOR DOORS UP TO 3.5M HIGH
1 TO.G02VA 2-CHANNEL REMOTE CONTROL	



TABLE OF DIMENSIONS OF SECTIONAL GARAGE DOORS

OPENING WIDTH, ORDERING SIZE		So	
OPENING HEIGHT, ORDERING SIZE		Ho	
HEIGHT OF THE ENTRY LUMEN		Hw	Ho - 150 mm
ENTRY LUMEN WIDTH		Sw	So
MINIMUM REQUIRED LINTEL HEIGHT		N	
FORWARD GUIDANCE, SPRINGS FRONT (ON LINTEL)	MANUAL DOOR	N	200 mm
	AUTOMATED DOOR	N	
REAR GUIDE, REAR GUIDE SPRINGS	MANUAL DOOR	N	100 mm
	AUTOMATED DOOR	N	150 mm
MINIMUM DEPTH OF THE ROOM WITH FREE SPACE UNDER THE CEILING		D	Lpn + 100 mm
MINIMUM WIDTH OF THE LEFT LATERALSPACE		Bl	80 mm
MINIMUM WIDTH OF THE RIGHT LATERALSPACE		Br	80 mm
DOOR GUIDE LENGTH		Lp	Ho + 460 mm
DRIVE GUIDE LENGTH		Lpn	3600 or 3900 mm

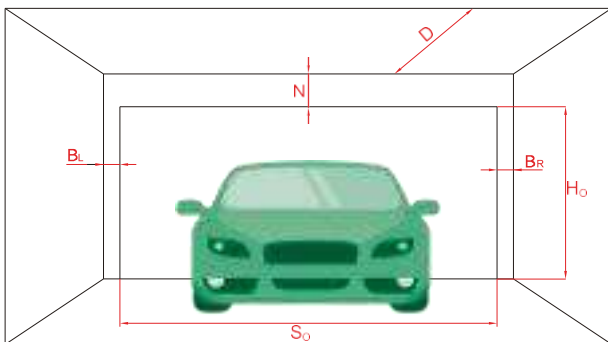

Ho – opening height

So – opening width

N – minimum required lintel height

D – minimum depth of the room with free space under the ceiling

Br – minimum width of the right side space

Bl – minimum width of the left side space

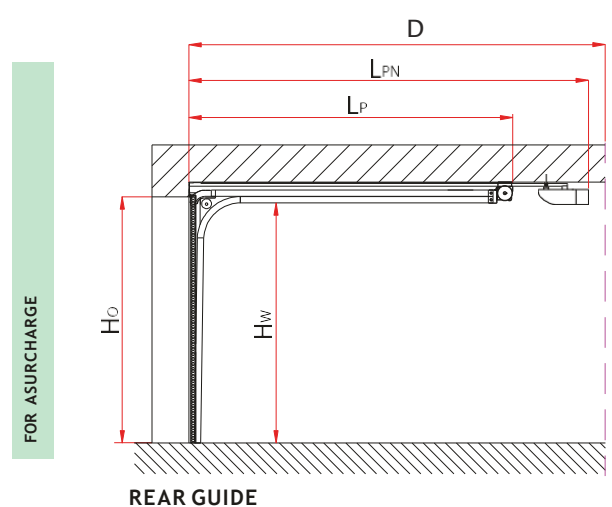
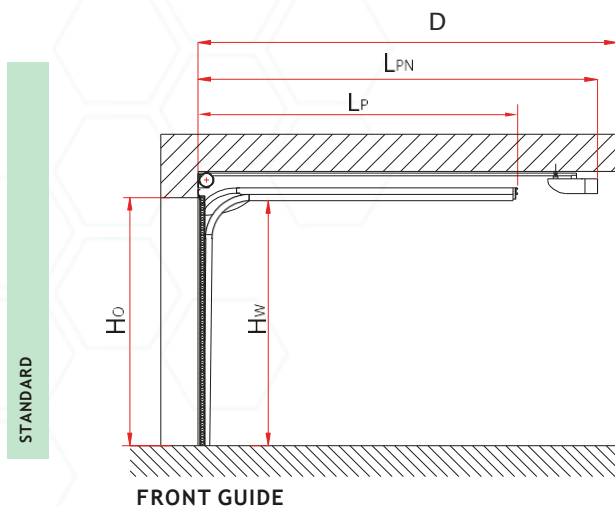



SECTIONAL INDUSTRIAL DOORS



Industrial sectional doors are used in multi-family residential buildings, public buildings and industrial buildings. Due to their purpose and specific application, industrial doors can be equipped with windows, aluminium panels, ventilated panels or passage doors. For convenience of use, industrial doors can be equipped with a GfA Elektromaten or Beninca drive.

INDUSTRIAL SECTIONAL DOORS | CONSTRUCTION

Standard equipment:

- Door made of 40 mm thick panels filled with polyurethane foam finished with galvanised steel sheet
- Support frame – angles and guides made of galvanised steel profiles with a thickness of 2 mm
- Torsionsprings at the front

The lock, handle, grip, drive and bolt are added to the order at the Customer's request.

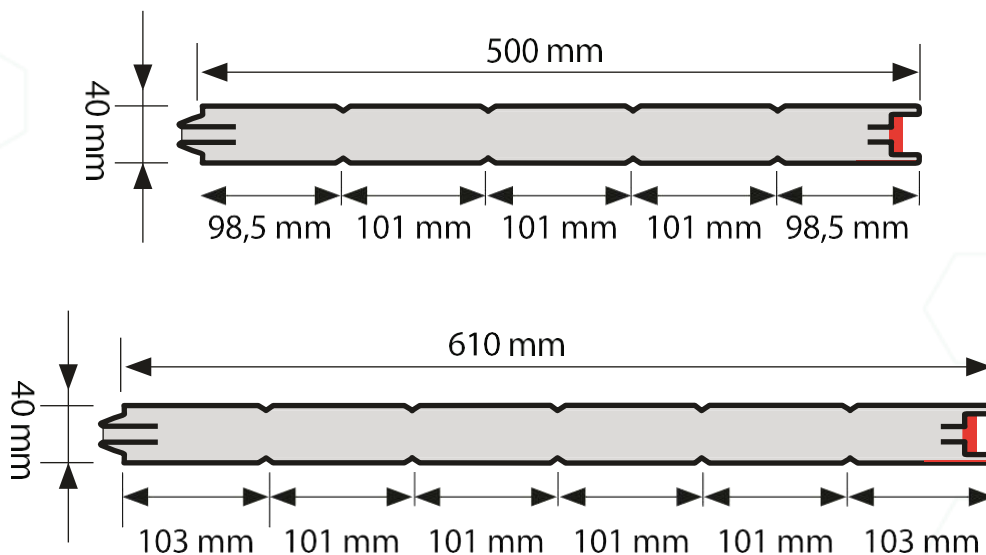

INDUSTRIAL SECTIONAL DOORS | STANDARD COLOURS OF RAL PALETTE VARNISHES AVAILABLE

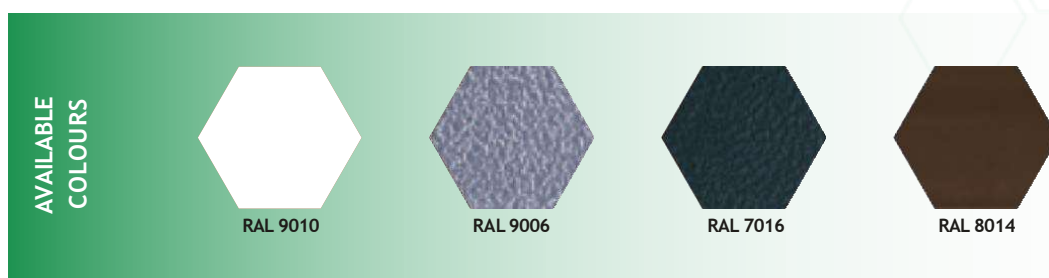

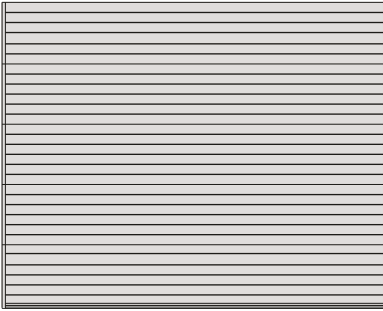

NARROW EMBOSSING DOOR

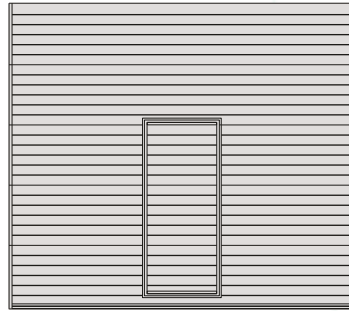

DOOR WITH A PASS-THROUGH DOOR

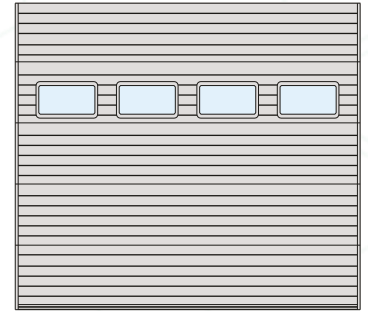

DOOR WITH WINDOWS

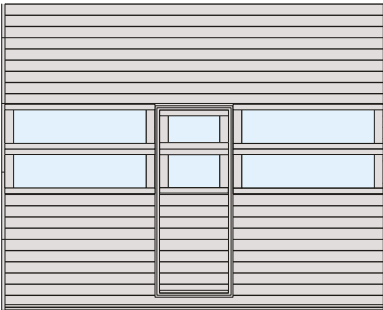

DOOR WITH PASS-THROUGH DOOR, PANELS WITH ALUMINIUM GLAZED SECTION

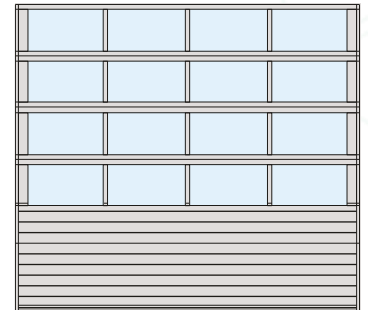
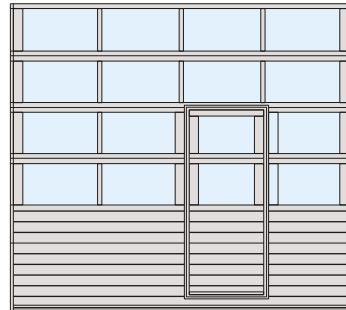

DOOR WITH ALUMINIUM GLAZED SECTION

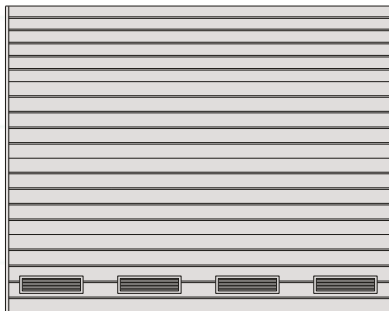

DOOR WITH VENTILATION GRILLES

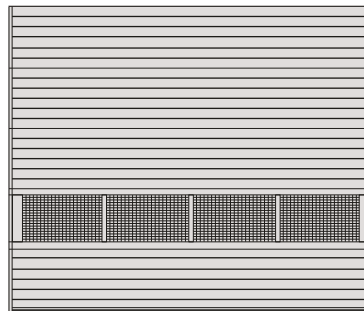

DOOR WITH VENTILATED PANEL



INDUSTRIAL SECTIONAL DOORS | TYPES OF GUIDES

DIMENSION TABLE FOR INDUSTRIAL DOORS

	STANDARD GUIDES	STANDARD GUIDES WITH AN ELEVATION	LOW GUIDES	ANGULAR GUIDES	ANGULAR GUIDES WITH ELEVATION	VERTICAL GUIDE SHAFT AT HEIGHT OF LINTEL
Pp	+	+		+	+	
Pt			+			
Sw	So	So	So	So	So	So
Hw	Ho	Ho	Ho - 35 ¹ , Ho - 135 ²	Ho	Ho	Ho
N	420 mm	420 mm + N	200 mm [Nr] 300 mm [Na]	420 mm	420 mm + N	Ho + 300 mm
Br, Bl	80 mm	80 mm	80 mm	80 mm	80 mm	80 mm
B1	250 mm	250 mm	250 mm	250 mm	250 mm	250 mm
B2	350 mm	350 mm	350 mm	350 mm	350 mm	350 mm
D	Ho + 650 mm	Ho - N + 650 mm	Ho + 1100 mm			

¹FOR MANUAL GATES

²FOR AUTOMATIC GATES

- Pp - FRONT GUIDE, SPRINGS AT THE FRONT OF THE DOOR
- Pt - REAR GUIDE, SPRINGS AT THE BACK OF THE DOOR
- So - OPENING WIDTH, ORDERING DIMENSION
- Ho - OPENING HEIGHT, ORDERING DIMENSION
- Sw - ENTRY LUMEN WIDTH
- Hw - HEIGHT OF THE ENTRY LUMEN
- N - MINIMUM LINTEL HEIGHT
- Nr - MINIMUM HEIGHT FOR MANUAL DOORS

- Na - MINIMUM HEIGHT FOR AUTOMATIC GATES
- D - MINIMUM DEPTH OF THE ROOM WITH FREE SPACE UNDER THE CEILING
- Br - MINIMUM WIDTH OF THE RIGHT LATERAL SPACE
- Bl - MINIMUM WIDTH OF THE LEFT LATERAL SPACE
- B1 - MINIMUM WIDTH OF THE SIDE SPACE FOR DOORS WITH WINCH
- B2 - MINIMUM WIDTH OF THE SIDE SPACE FOR DOORS WITH DRIVE

STANDARD GUIDES

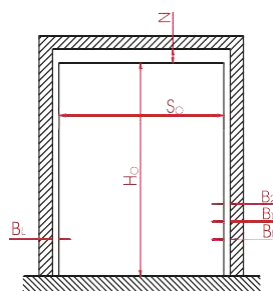
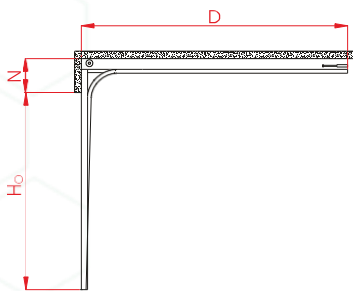

INTERNAL VIEW

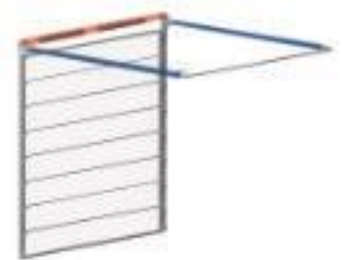

ANGULAR GUIDES

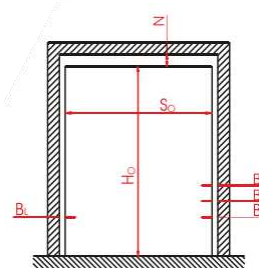
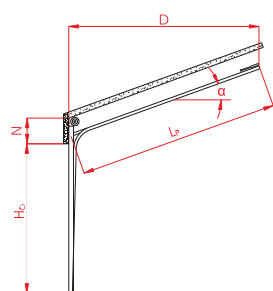

INTERNAL VIEW

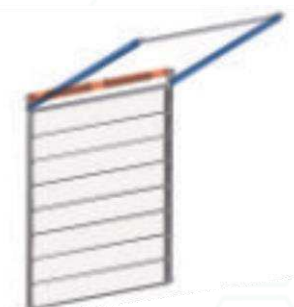

STANDARD GUIDES WITH AN ELEVATION

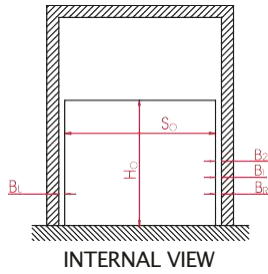
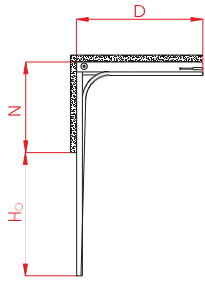

ANGULAR GUIDES WITH ELEVATION

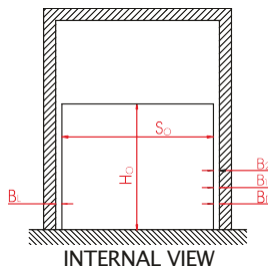
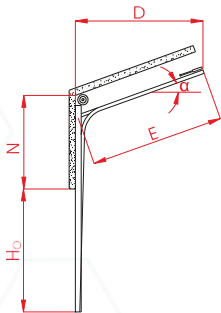

VERTICAL GUIDES (SHAFT AT INTEL HEIGHT)

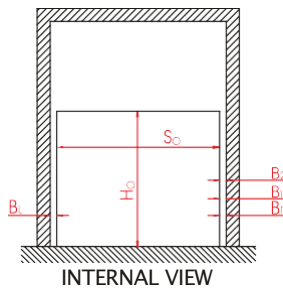
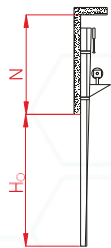

REAR LOW GUIDE

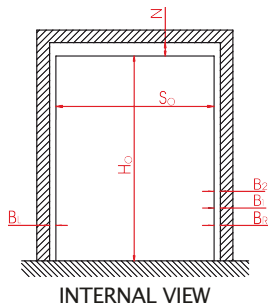
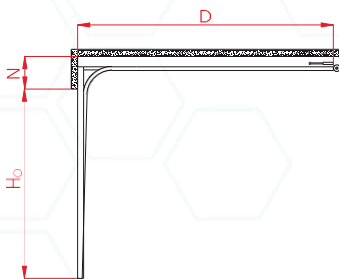



The GfA Elektromaten drive is mounted on a drive shaft mounted to the lintel. Lateral locking with a microswitch can be used (additional equipment table).

When ordering a drive in accordance with the table of dimensions of the available guides, the ordered set includes:

GFA	DRIVE TYPE		
	SE 5	SE 9	SE 14
DOOR AREA	Up to 16m ² So upto 5000 mm Ho upto 5000 mm	Up to 26 m ²	over 26 m ²
STANDARD EQUIPMENT	<ul style="list-style-type: none"> ■ TS-970 CONTROL PANEL: UP-STOP-DOWN [AUTOMATIC] ■ POWER SUPPLY 3Ph ~400V ■ ELECTRONIC LIMIT SWITCH ACCESSIBLE FROM THE OPERATOR LEVEL ■ OPTICAL SAFETY BAR FOR THE BOTTOM GATE EDGE: TRANSMITTER + RECEIVER ■ EMERGENCY MANUAL OPERATION MECHANISM - TYPE SK WITH CHAIN 		

GFA ELEKTROMATEN DRIVES



GFA ELEKTROMATEN DRIVE



TS-970 DOOR CONTROLLER

New in our offer are the Italian drives for industrial gates – Beninca.

Jack Model.24 is characterized by:

- **compact size** (11 cm wide), which allows quick and easy installation even in confined spaces
- perfect for automation of large doors (up to 35 m²) or where **intensive use** is required
- **encoder** guarantees the highest safety and precision during door movement
- **built-in STC system** for precise torque management
- guarantee of operation even in the event of a power failure thanks to batteries that can be perfectly integrated with the engine (2 1.2 Ah batteries)
- **built-in battery charging card**
- **anti-crushing system** with amperometric obstacle detection
- **built-in quick release system** in manual mode



JACK.24 actuator is available in two versions:

BENINCA	DRIVE TYPE	
	JACK24.50	JACK24.80
DOOR AREA	up to 20 m ²	up to 35 m ²
TORQUE	50 Nm	80 Nm

ACCESSORIES



CHAIN DRIVE



PANEL WITH ALUMINIUM SECTION



PVC VENTILATION GRILLE, COLOURS: WHITE, GRAY, BROWN, BLACK



PVC FRAME WINDOW

ADDITIONALEQUIPMENT

PASS-THROUGHDOOR (830 X 2210MM LUMEN) WITH 140MM THRESHOLD
PASS-THROUGHDOOR (830 X 2210MM LUMEN) WITH 28 MM THRESHOLD
HANDLE WITH LOCK
PVC VENTILATION GRILLE (EXT. DIM. 460MM X 135MM)
WINDOW (EXT. DIM. OF FRAME 640MM X 336MM)
PANELS OUTSIDE THE STANDARD COLLECTION
GLAZED ALUMINIUM PANEL
DOUBLE-SIDE HANDLE
LATCH/BOLT-ADDITIONAL INSIDE CLOSURE
LOW GUIDE WITH SPRING ATREAR

SOMFY - DRIVES AND ACCESSORIES

SOMFY DEXXO OPTIMO DRIVE UP TO 10M2
SOMFY DEXXO PRO DRIVE UP TO 15M2
SOMFY DEXXO SMART 800 IO DRIVE (2 KEYGO IO REMOTES)
SOMFY DEXXO SMART 1000 IO DRIVE (2 KEYGO IO REMOTES)
SOMFY DRIVE GUIDE 2.9UP TO 2.4 M HEIGHT (CHAIN)
SOMFY DRIVE GUIDE 2.9UP TO 2.4 M HEIGHT (BELT)
SOMFY 3.5 DRIVE GUIDE UP TO 3 M HEIGHT (CHAIN)
SOMFY 3.5 DRIVE GUIDE UP TO 3 M HEIGHT (BELT)
SOMFY 2-CHANNEL REMOTE CONTROL
SOMFY 4-CHANNEL REMOTE CONTROL
SOMFY 4-CHANNEL KEYGO IO REMOTE CONTROL
MASTER PHOTOCELL
EMERGENCY DISCONNECTION OF THE DRIVE WITH AN INSERT
EMERGENCY POWER SUPPLY BATTERY
TAHOMA SWITCH PRO

BENINCA - DRIVES AND ACCESSORIES

BENINCA DRIVE - JIM.3 UP TO 11M2
BENINCA DRIVE - JIM.4 UP TO 22M2
DRIVE GUIDE - PTC.3 UP TO 2.5 M
DRIVE GUIDE - PTC.4 UP TO 3,5 M
BENINCA 2-CHANNEL REMOTE CONTROL
BENINCA 4-CHANNEL REMOTE CONTROL
PUPILLA PHOTOCELL
EMERGENCY DRIVE DISCONNECTION
JACK24.50 UP TO 20 M2
JACK24.50 UP TO 35 M2

GFA - INDUSTRIAL DOOR DRIVES AND ACCESSORIES

GFA SE 5 DRIVE
GFA SE 9 DRIVE
GFA SE 14 DRIVE
2-CHANNEL REMOTE CONTROL
4-CHANNEL REMOTE CONTROL
RF RECEIVER

DEDICATED TO INDUSTRIAL DOORS

CHAIN DRIVE
ANGULAR, VERTICAL GUIDES WITH ELEVATION
PREPARATION FOR INSTALLATION OF THE DRIVE [ONLY FOR INDUSTRIAL DOORS]

DEDICATED TO FENCE GATES

BENINCA DRIVES FOR DOUBLE SWING FENCE GATES UP TO 2.1M
BENINCA DRIVES FOR SLIDING FENCE GATES UP TO 400 KG
BENINCA DRIVES FOR SLIDING FENCE GATES UP TO 500 KG

ALUMINIUM JOINERY



ALUMINIUM JOINERY

Aluminium is ideal for the construction of spatial structures, both internal and external, as it is extremely functional, light, durable, and resistant to external factors. In combination with glass, it gives the building style and a modern look.

Royal Doors manufactures a wide range of aluminium joinery, including:

- doors (including automatic, HS type sliding, evacuation, smoke extraction, aeration)
- fire doors of the Aluprof MB –78EI system
- windows
- separating walls, partitions, office boxes
- façades
- vestibules
- winter gardens
- pergolas.

We can act as contractors, but also complete individually quoted orders.

We offer assistance from consultancy through valuation and design up to and including assembly.

For our projects we use aluminium systems from well-known and respected manufacturers Ponzio and Aluprof.



AluprofSA belongs to the Capital Group of Grupa Kęty SA. The company is one of the leading manufacturers of aluminium systems in Europe. Aluprof aluminium systems allow the construction of many different types of windows and doors, depending on the scope of application and detailed requirements for functionality, aesthetics, thermal insulation, burglary resistance, smoke resistance or fire resistance.



Ponzio is a manufacturer and one of the largest suppliers of aluminium systems worldwide. The systems manufactured by Ponzio have the necessary approvals for use in construction, and the Ponzio Group's paint and anodizing shops are among the largest in Europe. They hold Qualicoat quality certificates in the field of powder coating and Qualanod in the field of anodizing.





TECHNICAL INFORMATION

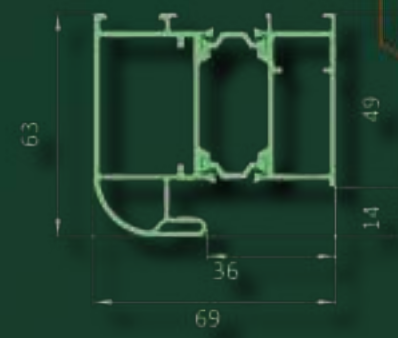

ASSORTMENT

LEAF 40 TECHNICAL - 7016/9010/8017
LEAF 40 TECHNICAL - 7035
LEAF 55 STANDARD - FULL STANDARD COLOUR
LEAF 55PREMIUM /PREMIUM PLUS - FULL STANDARD COLOUR
LEAF 72 STANDARD - FULL STANDARD COLOUR
LEAF 72PREMIUM /PREMIUM PLUS - FULL STANDARD COLOUR
LEAF 72PREMIUM H PLUS - FULL STANDARD COLOUR
LEAF 85 STANDARD-FULL STANDARD COLOUR
LEAF 85PREMIUM - FULL STANDARD COLOUR
LEAF 101 MASTER THERM STANDARD COLOUR
SURCHARGE FOR A LEAF IN EXCLUSIVE COLOUR
DOUBLE-SIDED DECOR INOX/BLACK
SINGLE-SIDED DECOR INOX/BLACK
ANTI-BURGLARYPINS
CLOSING C-CHANNEL
BLACKHINGE & INSERT
SURCHARGE TO 72DOUBLE-LEAF IN CL. RC2(INSET IN CL. B, STP-H/K2HANDLE)
SURCHARGE TO 85DOUBLE-LEAF IN CL. RC2(INSET IN CL. B, STP-H/K2HANDLE)
SURCHARGE TO 101 MASTER TER MIN CL. RC2(INSET IN CL. C, STP-OWHANDLE)
ELECTRIC STRIKE (TOTALPRICE INCLUDING PREPARATION) DAY/NIGHT FUNCTION
AVERSIVE/REVERSIBLE FIRE ELECTRICSTRIKE
ELECTRIC STRIKE FOR ANTI-BURGLARYDOORS
REED SWITCH
VENTILATION GRILLE INOX/BLACK
PVC VENTILATION GRILLE
ALUMINIUM DRIP CAP
LEAF-COLOURED LAMINATED STEEL DRIP CAP
3DHINGE COVERS - PRICE FOR 1HINGE - (FREE FOR DOORS ON STEEL-WOODEN FRAME)
BOTTOM PANEL WITH VENT. GRILLE INOX/BLACK-DOUBLE-SIDED
INOX/BLACKBOTTOM PANEL SINGLE SIDE
INOX/BLACKBOTTOM PANEL DOUBLE SIDED
INOX/BLACKCENTRE PANEL ONE-SIDED
INOX/BLACKCENTRE PANEL DOUBLE-SIDED
BOTTOM INOX PANEL +MIDDLE INOX PANEL - SINGLE-SIDED
BOTTOM INOX PANEL +MIDDLE INOX PANEL - DOUBLE-SIDED
BOTTOM PANEL WITH VENTILATION GRILLE FUNCTION +INOX CENTRE PANEL - DOUBLE-SIDED

CONTINUED ASSORTMENT

CABLE GLAND
PREPARATION FOR ELECTRIC STRIKE (PURCHASE OF DOORS WITHOUT STRIKE IN THE SET)
SELF-CLOSING DEVICE (TOTAL PRICE OF SELF-CLOSING DEVICE WITH PREPARATION)
PVC VENTILATION SLEEVES
INOX VIEWFINDER Ø 14MM FOR 55MM THICK DOORS
BLACK VIEW FINDER Ø 14MM FOR 55MM THICK DOORS
INOX VIEWFINDER Ø 16MM FOR 72MM AND 85MM THICK DOORS
BLACK VIEW FINDER Ø 16MM FOR 72MM AND 85MM THICK DOORS
DDS2 DIGITAL VIEWFINDER (50 PHOTOS IN MEMORY)
VIEWFINDER AT CUSTOM HEIGHT
FIRE SAFETY VIEW FINDER
REINFORCEMENT FOR RAPPER (PURCHASE OF DOORS WITHOUT WRAPPER INCLUDED)
REINFORCEMENT FOR SELF-CLOSING DEVICE (PURCHASE OF DOORS WITHOUT A DOOR CLOSER INCLUDED)
UPPER LOCK FOR TECHNICAL DOORS
WINKHAUS MULTI-POINT LATCH AND HOOK LOCK
MACO LOCK FOR 85MM THICK DOORS
POWER ADAPTER FOR ELECTRIC LOCK OR STRIKE
PAINTING IN RAL COLOURS (NOT APPLICABLE FOR DEEP EMBOSSED)
TWO-COLOUR LEAF

FRAMES | FRAME WIDENING

STEEL FRAME FD-25/21/N/O
STEEL FRAME FD-21/N
STEEL FRAME FD-21/C
STEEL FRAME FD-21/B
STEEL FRAMES FD-25/21/B, FD-25/21/C, FD-25/12 FOR EXTERIOR DOOR 55-72-85 THICK STANDARD COLOUR
STEEL AND WOODEN DOOR FRAME FOR EXTERIOR DOORS 55-72-85 STANDARD COLOUR WITH THREE-SIDED AND FOUR-SIDED UP STAND
STEEL AND WOODEN FRAME FOR MASTER THERM 101 DOORS STANDARD COLOUR
STEEL AND WOODEN FRAME FOR SENATORE DOORS
SURCHARGE FOR STEEL AND STEEL-WOODEN FRAME IN EXCLUSIVE COLOUR
EXTENSION FOR STEEL AND WOODEN FRAME 30MM
EXTENSION FOR STEEL AND WOODEN FRAME 55MM
ALUMINIUM FRAME 72MM THICK
ALUMINIUM FRAME 85MM THICK
SURCHARGE FOR 72MM THICK ALUMINIUM FRAME WITH 3D HINGE
SURCHARGE FOR 85MM THICK ALUMINIUM FRAME WITH 3D HINGE OPTION
ALUMINIUM FRAME FILLING

SILLS | SILL EXTENSIONS

STAINLESS STEEL SILL, 40 MM THICK, WIDTH 800-900MM

STAINLESS STEEL SILL, 40 MM THICK, WIDTH 1000MM

STAINLESS STEEL SILL 55-72MMTHICK, WIDTH 800-900 MM

STAINLESS STEEL SILL 55-72MMTHICK, WIDTH 1000 MM

ALUMINIUM SILL

WOODEN SILL FOR SECURITY DOORS (OAK, NATURAL WOOD COLOUR)

SUB-SILLEXTENSION 70

SUB-SILL EXTENSION 120

SUB-SILL EXTENSION 150

ADHESIVE FOR SUB-SILLEXTENSION

HANDLES

STP-IINOX/BLACK HANDLE

OLARIX HANDLE

OLARIXWC HANDLE

SAFETY HANDLE

AXA TORONTO FLEX HANDLE

AXA ROYALFLEX INOX HANDLE

AXA ROYALFLEX BLACK HANDLE

STP-OWHANDLE

STP-H/K2HANDLE

STP-HINOX/BLACK HANDLE

STP-HHANDLE-GRIP

PTZ HANDLE

RIGID CHAIN (SURCHARGE FOR PTZ FITTINGS)

INSERTS

W5 INSERT FOR 40MM THICK DOORS (26/36SPACING)
INSERT FOR 55MM THICK DOORS (45/30+45/30G-EXT., 30/45+30/45G-INT.)
72MM THICK DOOR INSERT (55/40+55/40G-EXT., 40/55+40/55G-INT.)
101MM THICK DOOR INSERT (55/70+55/70G-EXT., 70/55+70/55G-INT.)
85 MM THICK DOOR INSERT (60/50+60/50G-EXT., 50/60+50/60G-INT.)
47-55MMTHICK DOOR INSERT IN CL. B
47-55MMTHICK DOOR INSERT IN CL. C
72MM THICK DOOR INSERT IN CL. B
85MM THICK DOOR INSERT IN CL. B
BLACKINSERT AND HINGES (STANDARD KIT SURCHARGE)

WRAPPERS

AMSTERDAM STRAIGHT100 WRAPPER - INOX
AMSTERDAM STRAIGHT100 WRAPPER - BLACK
AMSTERDAM STRAIGHT 120 WRAPPER - INOX
AMSTERDAM STRAIGHT 120 WRAPPER - BLACK
AMSTERDAM STRAIGHT 150 WRAPPER - INOX
AMSTERDAM STRAIGHT 150 WRAPPER - BLACK
MONTREAL STRAIGHT100 WRAPPER - INOX
MONTREAL STRAIGHT100 WRAPPER - BLACK
MONTREAL STRAIGHT 120WRAPPER - INOX
MONTREAL STRAIGHT 120WRAPPER - BLACK
MONTREAL STRAIGHT 150WRAPPER - INOX
MONTREAL STRAIGHT 150WRAPPER - BLACK
MEDIOLAN BENT100 W RAPPER - INOX
MEDIOLAN BENT100 W RAPPER - BLACK
MEDIOLAN BENT150 WRAPPER - INOX
MEDIOLAN BENT150 WRAPPER - BLACK
FERRARA 100 WRAPPER - INOX
FERRARA 100 WRAPPER - BLACK
FERRARA 150 WRAPPER - INOX
FERRARA 150 WRAPPER - BLACK
AREZZO 100 WRAPPER - BLACK
AREZZO 150WRAPPER - BLACK
PUSH BUTTON

G

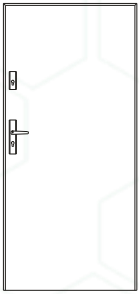

TECHNICAL INFORMATION | SOLID DOOR MODELS - SHALLOW EMBOSSED

T01

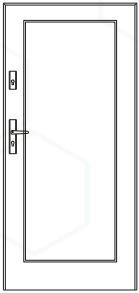

T02

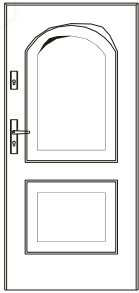

T30

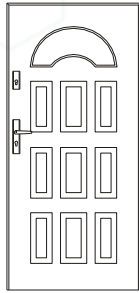

T32

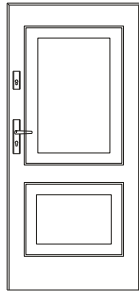

T34

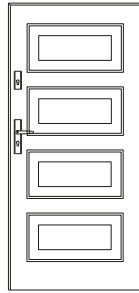

T36

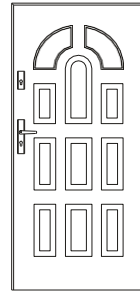

T41

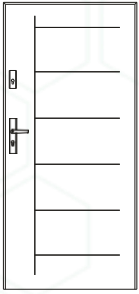

T42

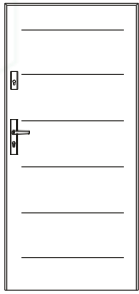

T43

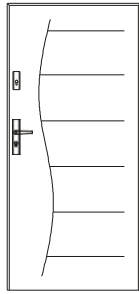

T44

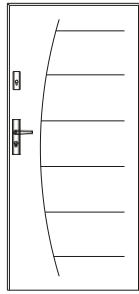

T45

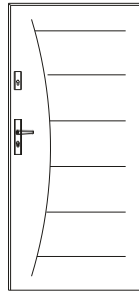

T46

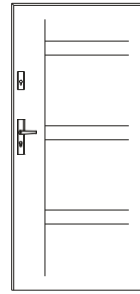

T47

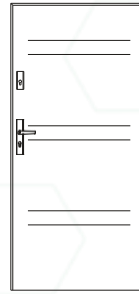

T48

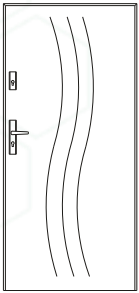

T49

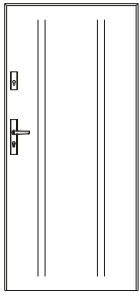

T50

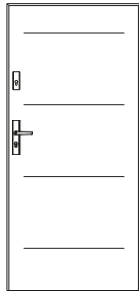

T51

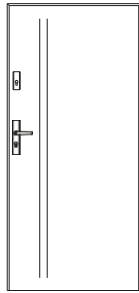

T52

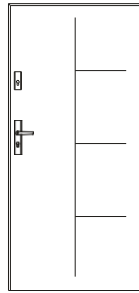

T53

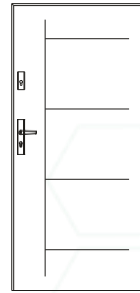

T54

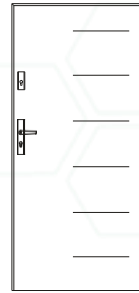

T55

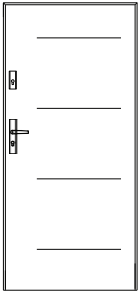

T58

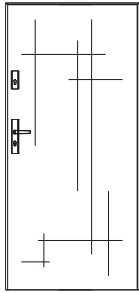

T59

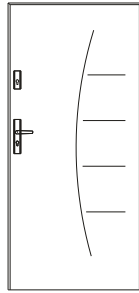

T60

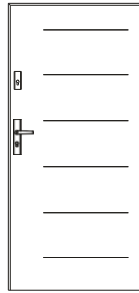

T61

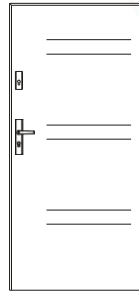

T62

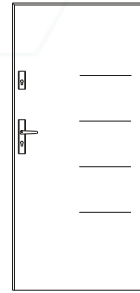

T63

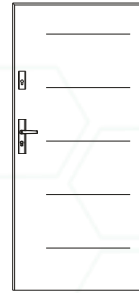

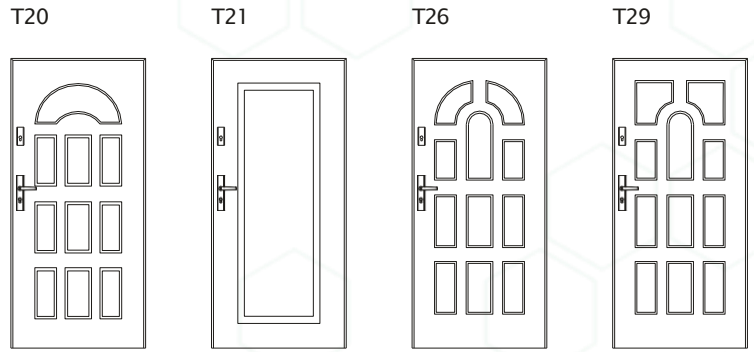

TECHNICAL INFORMATION | DOOR MODELS WITH DECORS

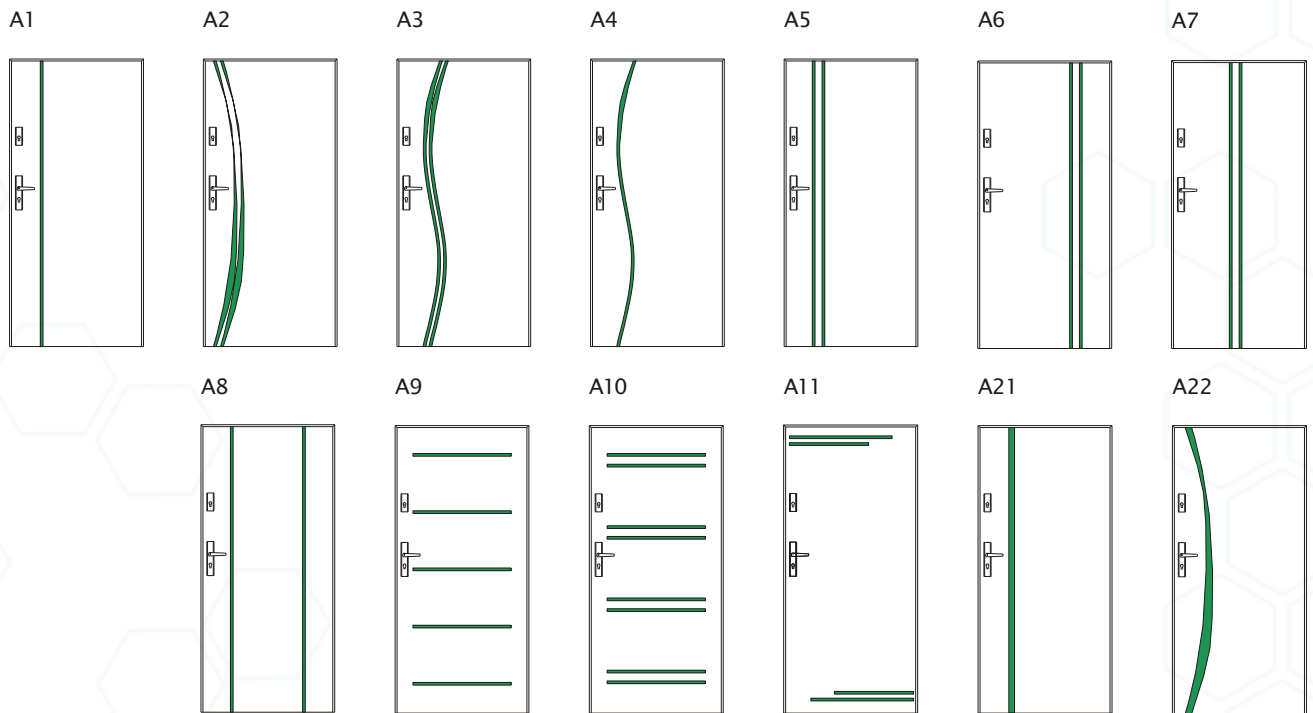

TECHNICAL INFORMATION | DOOR MODELS WITH GLAZING

PVC FRAMES

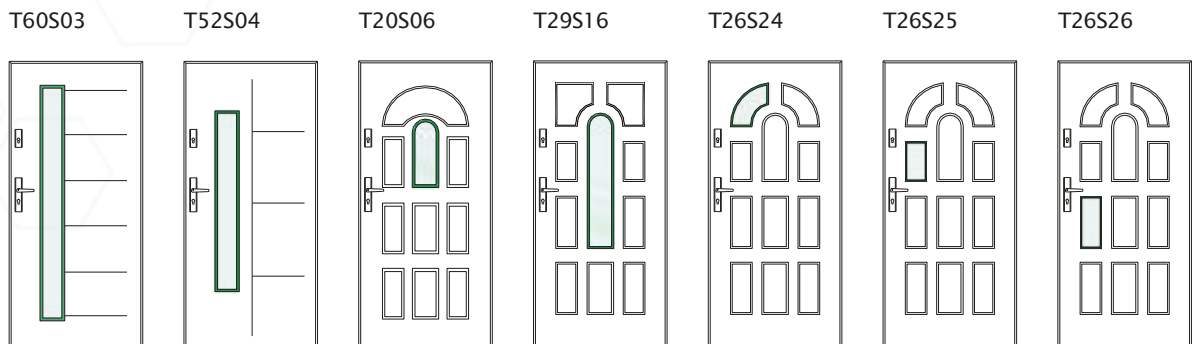

INOX/ BLACK FRAMES

T50S29

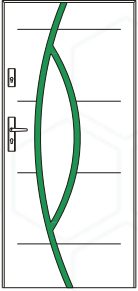

T01S30

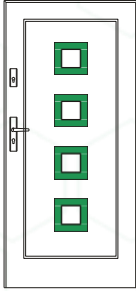

T01S31



T01S32

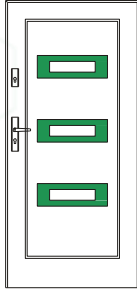

T01S33

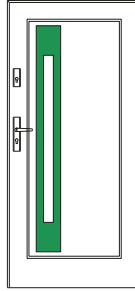

T61S33

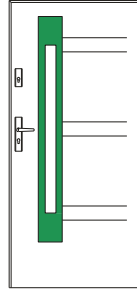

T01S34

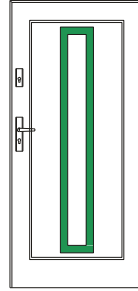

T49S34

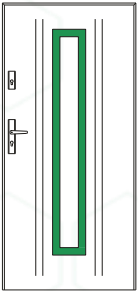

T52S34

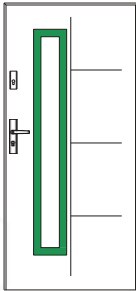

T63S34

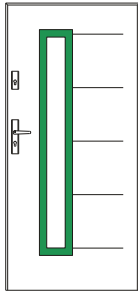

G S35

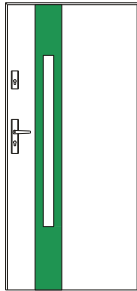

G S36

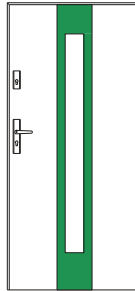

T41S36

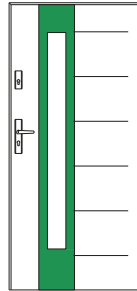

T41S37

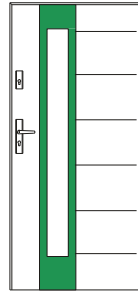

T01S38

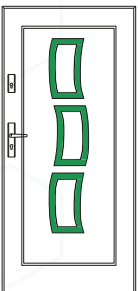

T01S39

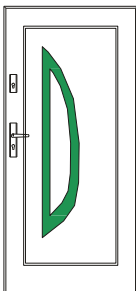

T42S40

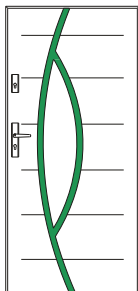

T01S41

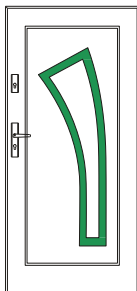

T44S42

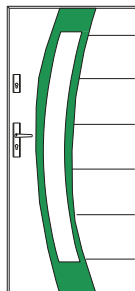

T41S43

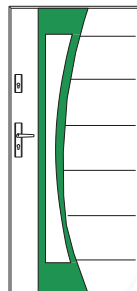

T59S43

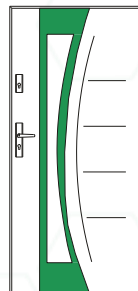

T42S44

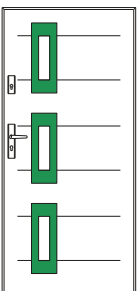

T41S45

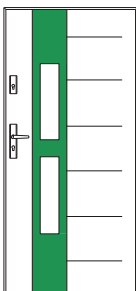

T01S46

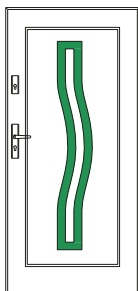

T01S47

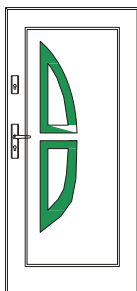

G S48

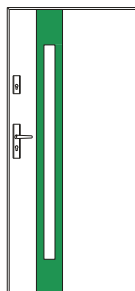

G S49

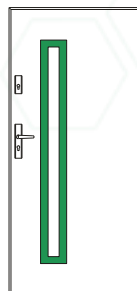

G S51

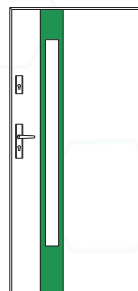

INOX/BLACK FLUSH FRAMES

T60S50

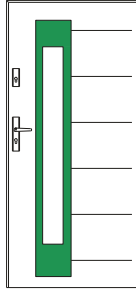

G S53

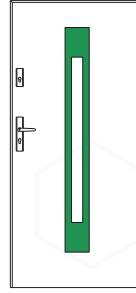

T62S53

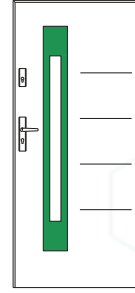

G S54

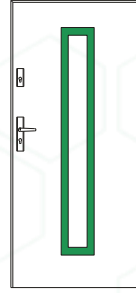

INOX/BLACK NARROW FRAMES

T53S60

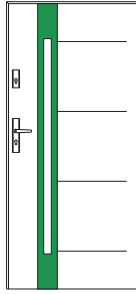

T41S61

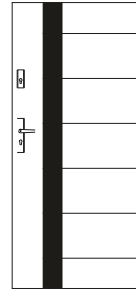

T54S61

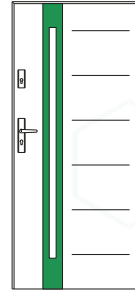

T49S62

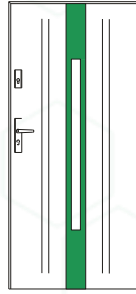

INOX/BLACK NARROW FLUSH FRAME

T48S70

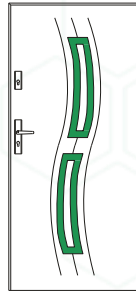

TECHNICAL INFORMATION | DOOR MODELS WITH GLAZING AND DECOR

S33
A46 NARROW

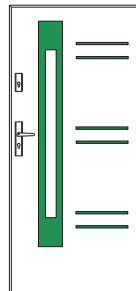

S36
A41 WIDE

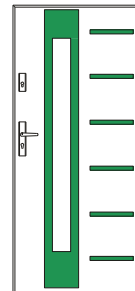

S60
A53 NARROW

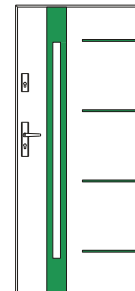

S62
A49 NARROW

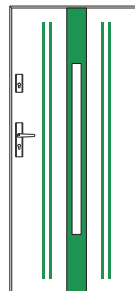

T60S80

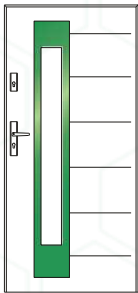

G S80

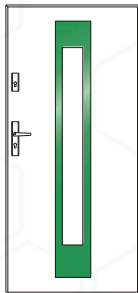

T55S81

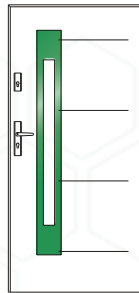

G S81

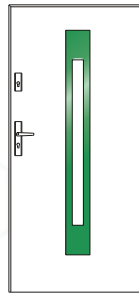

TECHNICAL INFORMATION
| DOOR MODELS WITH P4 SAFETY GLAZING
WITH OPTIONAL 72 & 85 MM DOORS IN SAFETY CLASS RC2

T01S33-P4

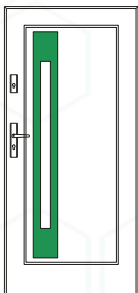

T61S33-P4

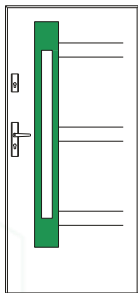

T01S34-P4

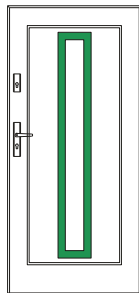

T49S34-P4

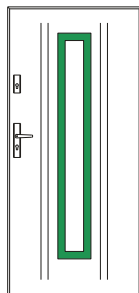

T52S34-P4

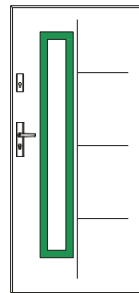

T63S34-P4

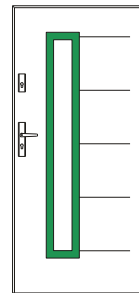

G S35-P4

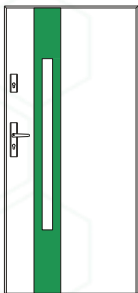

G S36-P4

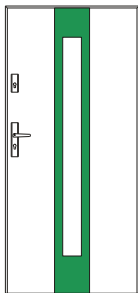

T41S36-P4

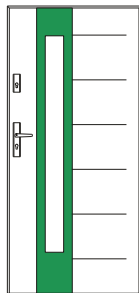

T41S37-P4

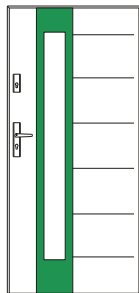

T53S60-P4

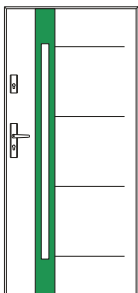

T41S61-P4

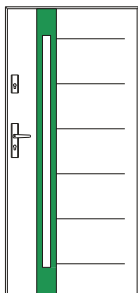

T54S61-P4

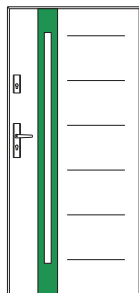

T49S62-P4

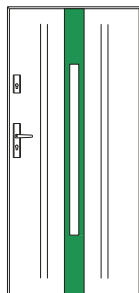



Royal Doors

www.royaldoors.co.uk